



**Digital Video Broadcasting (DVB);  
IP Datacast: Implementation Guidelines for  
Mobility;**

**Part 1: IP Datacast over DVB-H**

**DVB Document A117 Rev.2 - 1  
September 2008**

---

# Contents

Intellectual Property Rights .....	4
Foreword .....	4
Introduction .....	4
1 Scope .....	5
2 References .....	5
2.1 Normative references .....	5
2.2 Informative references .....	6
3 Definitions and abbreviations .....	6
3.1 Definitions .....	6
3.2 Abbreviations .....	7
4 Background .....	7
4.1 Overview .....	8
4.2 network_id and original_network_id .....	9
4.3 transport_stream_id .....	9
4.4 platform_id .....	9
4.5 ESG_URI .....	9
4.6 IPDCOperatorId and IPDCCKMSId .....	9
4.7 Rules of uniqueness .....	9
4.8 Mobility concepts .....	10
4.8.1 Basic handover concept .....	10
4.8.2 Basic concept for roaming and special mobility cases .....	10
5 Use cases .....	11
5.1 Handover use cases .....	11
5.1.1 Overview of handover use cases .....	11
5.1.2 Detection of alternative service reception parameters .....	12
5.1.2.1 Handover Use Case 1: Change of cell_id or subcell_id .....	12
5.1.2.2 Handover Use Case 2: Change of cell_id and network_id .....	13
5.1.2.3 Handover Use Case 3: Change of cell_id and transport_stream_id .....	15
5.1.2.4 Handover Use Case 4: Change of cell_id and network_id and transport_stream_id .....	16
5.1.2.5 Handover Use Case 5: Change of Original Network .....	18
5.2 Roaming and special mobility use cases .....	19
5.2.1 Overview of Roaming and special mobility use cases .....	19
5.2.2 Description of use cases .....	21
5.2.2.1 Roaming Use Case 1 .....	21
5.2.2.2 Roaming Use Case 2 .....	21
5.2.2.3 Roaming Use Case 3 .....	21
5.2.2.4 Special Mobility Use Case 4 .....	22
5.2.2.5 Special Mobility Use Case 5 .....	22
6 Terminal behavior .....	23
6.1 General mobility procedure .....	23
6.2 Handover implementation guidelines .....	23
6.2.1 General procedure .....	23
6.2.2 Initialization .....	24
6.2.3 Determine list of candidate signals .....	25
6.2.4 Determine handover case .....	25
6.2.5 Monitor handover conditions .....	25
6.2.5.1 Parameters that may be used in monitoring and evaluating .....	26
6.2.5.2 Monitor existing signal quality .....	29
6.2.5.3 Evaluate alternative signal quality .....	30
6.2.6 Handover execution .....	32
6.2.6.1 Handover based on TPS and NIT .....	33
6.2.6.2 Handover based on INT, TPS and NIT .....	33

6.3	Roaming and special mobility cases implementation guidelines .....	34
6.3.1	Initialization .....	36
6.3.2	Search all the available roaming configurations in Broadcast Network.....	36
6.3.3	Categorize and select Roaming Configurations .....	36
6.3.3.1	Categorize Roaming Configurations .....	36
6.3.3.2	Select a Roaming Configuration.....	37
6.3.3.3	Mapping to use cases.....	37
6.3.4	Acquire roaming configurations via interactive network .....	37
6.3.5	Access an ESG .....	38
6.3.6	Validate an roaming configuration .....	38
<b>Annex A (normative): ESG bootstrap extension for mobility support.....</b>		<b>38</b>
A.1	Introduction.....	38
A.2	RoamingInformation Descriptor .....	38
A.2.1	Syntax .....	38
A.2.2	Semantics .....	39
A.2.3	Transport .....	40
<b>Annex B (informative): Bibliography .....</b>		<b>41</b>
History .....		42

---

## Intellectual Property Rights

IPRs essential or potentially essential to the present document may have been declared to ETSI. The information pertaining to these essential IPRs, if any, is publicly available for **ETSI members and non-members**, and can be found in ETSI SR 000 314: "*Intellectual Property Rights (IPRs); Essential, or potentially Essential, IPRs notified to ETSI in respect of ETSI standards*", which is available from the ETSI Secretariat. Latest updates are available on the ETSI Web server (<http://webapp.etsi.org/IPR/home.asp>).

Pursuant to the ETSI IPR Policy, no investigation, including IPR searches, has been carried out by ETSI. No guarantee can be given as to the existence of other IPRs not referenced in ETSI SR 000 314 (or the updates on the ETSI Web server) which are, or may be, or may become, essential to the present document.

---

## Foreword

This Technical Specification (TS) has been produced by Joint Technical Committee (JTC) Broadcast of the European Broadcasting Union (EBU), Comité Européen de Normalisation ELECTrotechnique (CENELEC) and the European Telecommunications Standards Institute (ETSI).

**NOTE:** The EBU/ETSI JTC Broadcast was established in 1990 to co-ordinate the drafting of standards in the specific field of broadcasting and related fields. Since 1995 the JTC Broadcast became a tripartite body by including in the Memorandum of Understanding also CENELEC, which is responsible for the standardization of radio and television receivers. The EBU is a professional association of broadcasting organizations whose work includes the co-ordination of its members' activities in the technical, legal, programme-making and programme-exchange domains. The EBU has active members in about 60 countries in the European broadcasting area; its headquarters is in Geneva.

European Broadcasting Union  
CH-1218 GRAND SACONNEX (Geneva)  
Switzerland  
Tel: +41 22 717 21 11  
Fax: +41 22 717 24 8

The present document is part 1 of a multi-part deliverable covering IP Datacast: Implementation Guidelines for Mobility, as identified below:

**Part 1:** "IP Datacast over DVB-H";

Part 2: "IP Datacast over DVB-SH".

---

## Introduction

IP Datacast over DVB-H is an end-to-end broadcast system for delivery of any types of digital content and services using IP-based mechanisms. An inherent part of the IPDC system is that it consists of a unidirectional DVB broadcast path and a bi-directional mobile/cellular interactivity path. IPDC is thus a platform for convergence of services from mobile/cellular and broadcast/media domains.

---

# 1 Scope

The present document presents guidelines on how to develop terminals and network infrastructure equipment to allow seamless handover within the scope of one IP Platform, one ESG, and one IPDC Operator, in order to continue IP Datacast service consumption. Additionally, the present document specifies enablers for mobility between IP Platforms, ESGs, and IPDC Operators.

---

# 2 References

References are either specific (identified by date of publication and/or edition number or version number) or non-specific.

- For a specific reference, subsequent revisions do not apply.
- Non-specific reference may be made only to a complete document or a part thereof and only in the following cases:
  - if it is accepted that it will be possible to use all future changes of the referenced document for the purposes of the referring document;
  - for informative references.

Referenced documents which are not found to be publicly available in the expected location might be found at <http://docbox.etsi.org/Reference>.

For online referenced documents, information sufficient to identify and locate the source shall be provided. Preferably, the primary source of the referenced document should be cited, in order to ensure traceability. Furthermore, the reference should, as far as possible, remain valid for the expected life of the document. The reference shall include the method of access to the referenced document and the full network address, with the same punctuation and use of upper case and lower case letters.

NOTE: While any hyperlinks included in this clause were valid at the time of publication ETSI cannot guarantee their long term validity.

## 2.1 Normative references

The following referenced documents are indispensable for the application of the present document. For dated references, only the edition cited applies. For non-specific references, the latest edition of the referenced document (including any amendments) applies.

- [1] ISO/IEC 13818-1: "Generic coding of moving pictures and associated audio information".
- [2] ETSI EN 302 304: "Digital Video Broadcasting (DVB); Transmission System for Handheld Terminals (DVB-H)".
- [3] ETSI TS 102 471: "Digital Video Broadcasting (DVB); IP Datacast over DVB-H: Electronic Service Guide (ESG)".
- [4] ETSI TS 102 470: "Digital Video Broadcasting (DVB); IP Datacast: Program Specific Information (PSI) / Service Information (SI); Part 1: IPDC over DVB-H".

## 2.2 Informative references

The following referenced documents are not essential to the use of the ETSI deliverable but they assist the user with regard to a particular subject area. For non-specific references, the latest version of the referenced document (including any amendments) applies.

- [5] ETSI TS 102 474: "Digital Video Broadcasting (DVB); IP Datacast over DVB-H: Service Purchase and Protection"
- [6] ETSI TS 102 472: "Digital Video Broadcasting (DVB); IP Datacast over DVB-H: Content Delivery Protocols".
- [7] ETSI TR 102 377: "Digital Video Broadcasting (DVB); DVB-H Implementation Guidelines".
- [8] ETSI TR 101 211: "Digital Video Broadcasting (DVB); Guidelines on implementation and usage of Service Information (SI)".
- [9] IEC 62002-1 "Mobile and portable DVB-T/H radio access - Part 1: Interface specification".
- [10] Jani Väire, Matti Puputti: "Soft handover in terrestrial broadcast networks", Proceedings of MDM2004.

## 3 Definitions and abbreviations

### 3.1 Definitions

For the purposes of the present document, the following terms and definitions apply:

**Cell:** geographical area that is covered with DVB-H signals delivering one or more particular transport streams throughout the area by means of one or more transmitters

NOTE: The cell may in addition contain repeaters. Two neighbouring cells may be intersecting, or fully overlapping. The cell\_id that is used to uniquely identify a cell is unique within each original\_network\_id. For hand-over purposes it is more convenient if the transport streams associated with the cell cover exactly the same area, or only one transport stream per cell is used.

**DVB Network:** collection of MPEG-2 Transport Streams, each carried in a multiplex, and transmitted on a single delivery system

NOTE: DVB Network is identified by network\_id.

**IP Flow:** flow of IP datagrams each sharing the same IP source and destination address

NOTE: An IP Flow is identified within an IP Platform by its source and destination addresses. IP Flows on different IP Platforms may have the same source/destination addresses, but are considered different IP Flows. IP Flows may be delivered over one or more IP Streams.

**IP Platform:** set of IP Flows managed by an organization

NOTE: The IP Platform represents a harmonized IP address space that has no address collisions. An IP Platform may span several Transport Streams within one or more DVB Networks. Several IP Platforms may co-exist in the same Transport Stream. IP Platform is identified by platform\_id.

**IP Stream:** physical mapping of an IP Flow to transport\_stream\_id, original\_network\_id, service\_id, component\_tag, and IP source/destination addresses

NOTE: An IP Stream is delivered on an MPE section stream.

**Multiplex:** stream of all the digital data carrying one or more services within a single physical channel (characterized by parameters like carrier frequency and modulation modes)

**Sub-Cell:** geographical area that is part of the cell's coverage area and that is covered with DVB-H signals by means of a transposer

NOTE: In conjunction with the cell\_id the cell\_id\_extension is used to uniquely identify a subcell.

**Transport Stream (TS):** stream of transport\_packets, as defined in ISO/IEC 13818-1 [1]

**IPDC Operator:** Characterized uniquely by IPDCOperatorId and IPDCkMSId.

Note: A physical IPDC Operator may have several IPDCOperatorIds which each map to an IPDC Operator in the defined sense.

**Home IPDC Operator:** The IPDC Operator that the terminal is registered to.

**Local IPDC Operator:** An IPDC Operator that himself offers services on a certain IP Platform and ESG.

**Roaming IPDC Operator:** An IPDC Operator that the terminal is not registered to, but that has a roaming contract with the Home IPDC Operator.

**IPDC Roaming:** Change of a terminal connection from an IPDC Operator to a Roaming IPDC Operator.

**IPDC Handover:** Change of the terminal connection (one or more of the parameters original\_network\_id, transport\_stream\_id, network\_id, cell\_id / subcell\_id) within the scope of one IPDC Operator (while accessing IPDC services).

**Home IP Platform:** The IP Platform(s) the terminal has been provisioned with by his Home IPDC Operator as its home configuration.

**Visited IP Platform:** An IP Platform which is not a Home IP Platform.

Note: The Home IPDC Operator may be a Local IPDC Operator on this IP Platform or not.

**Home ESG:** The ESG(s) the terminal has been provisioned with by his Home IPDC Operator as its home configuration.

**Visited ESG:** An ESG which is not a Home ESG.

Note: The Home IPDC Operator may be a Local IPDC Operator on this ESG or not.

**Roaming configuration:** a combination of platform\_id, ESG\_URI (provider\_URI and providerID in case of IPDC phase I), and the pair of IPDCOperatorId and IPDCkMSId;

**Unknown IPDC Operator:** An IPDC Operator for which a terminal is lacking information to identify whether an IPDC roaming contract with the Home IPDC Operator exists.

## 3.2 Abbreviations

For the purposes of the present document, the following abbreviations apply:

CBMS	Convergence of Broadcast and Mobile Services
CTA	clear-to-air
DVB	Digital Video Broadcasting
DVB-H	DVB-Handheld [2]
ESG	Electronic Service Guide [3]
IPDC	IP DataCast
NIT	Network Information Table
TS	Transport Stream
URI	<a href="#">Uniform Resource Identifier</a>

---

## 4 Background

The focus of the present clause is to provide a brief introduction on PSI/SI tables and descriptors used in IPDC in DVB-H Systems as well as to describe basic mobility concepts.

## 4.1 Overview

A DVB Network is uniquely identified by a `network_id`. A DVB Network consists of one or more Transport Streams (TSs), each being transmitted by one or more DVB signals. All emitting sites identified by `cell_ids` of a DVB Network do not need to transmit all TSs of the network. Information about a DVB Network is available within the NIT sub\_table (identified by `network_id`). The NIT lists all TSs and DVB signals available within the DVB Network. The NIT is carried within each DVB Network.

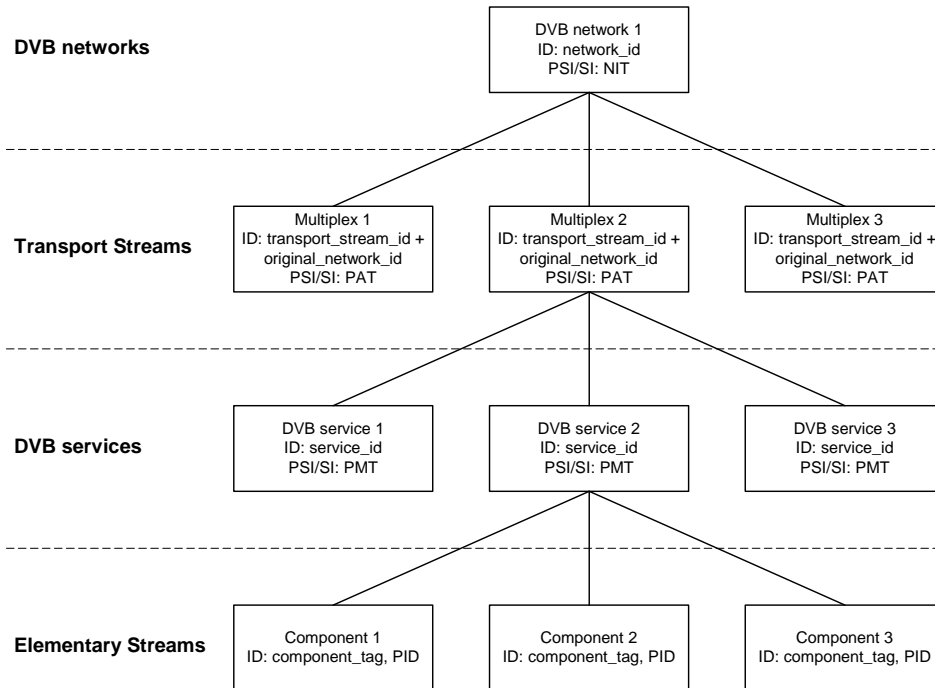

**Figure 1: Hierarchy of data streams in DVB-H (1)**

An IP Stream is a single data stream delivering an IP Flow. An IP Flow is a flow of IP datagrams, each sharing the same IP source and destination addresses, that represent the data content of a stream. An IP Stream represents an instantiation of such an IP Flow to `transport_stream_id`, `original_network_id`, `network_id`, `service_id`, `component_tag`, and IP\_source / destination addresses. An IP Flow belongs to exactly one IP Platform. Note that an IP Stream may be announced by multiple INT sub\_tables, possibly making it part of multiple IP Platforms.

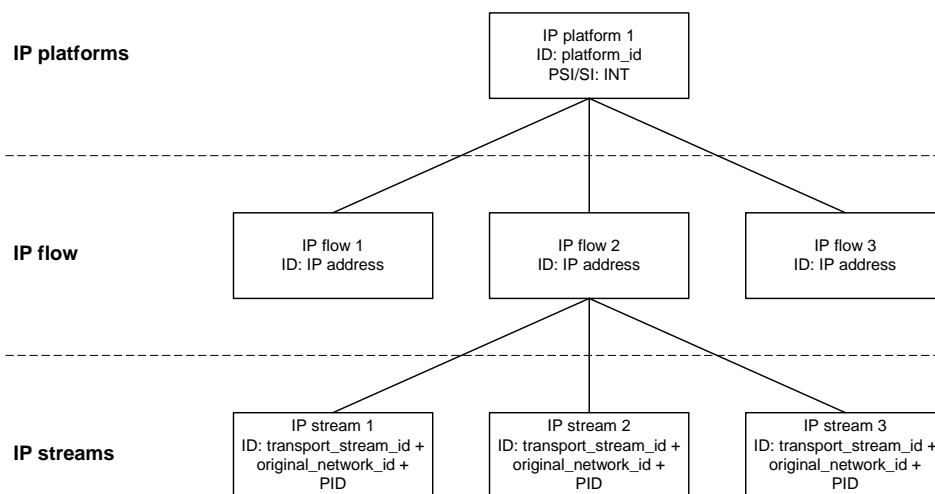

**Figure 2: Hierarchy of data streams in DVB-H (2)**

## 4.2 network\_id and original\_network\_id

In DVB, the `original_network_id` is defined as the `network_id` of the network where the TS originated. For terrestrial DVB the concept of an original network, with an `original_network_id`, could be interpreted as a sort of abstract hypothetical network feeding all real networks (in the sense of `network_id`) in e.g. a country. The `original_network_ids` are typically allocated by DVB on a per-country basis. For each country, a range of `network_ids` is allocated by DVB, which are all different from the `original_network_id`. It may happen that the `original_network_id` is the same as the `network_id` of the actual network.

## 4.3 transport\_stream\_id

From the point of view of the DVB-SI specification a DVB Network is simply a 'collection of MPEG-2 Transport Stream (TS) multiplexes transmitted on a single delivery system', with no mentioning of requirements for emission in all cells of the network. From the point of view of [4] there are therefore no particular rules whether a TS needs to be broadcast in all cells of a network. It is perfectly in line with [4] to have e.g. a nationwide network with a number of regional TSs, each with unique `transport_stream_id` and content.

## 4.4 platform\_id

The IP Platform represents a harmonized IP address space that has no address collisions. An IP Platform is identified by the `platform_id`.

## 4.5 ESG\_URI

An ESG is a special service describing IPDC Services available on an IP Platform. Several ESGs may co-exist on the same IP Platform. An ESG is uniquely identified by `ESG_URI` if the ESG is based on [3] v1.3.1 or later and by `providerURI` and `providerId` if the ESG is based on [3] v1.1.1 or v1.2.1.

## 4.6 IPDCOperatorId and IPDCKMSId

An IPDC Operator is an entity managing key streams. The `IPDCOperatorId` together with the `IPDCKMSId` (a.k.a. `CA_system_ID`) is used to identify the IPDC Operator.

The `IPDCOperatorId` is used in other IPDC specifications especially in the SPP context [5]. An integer value has been used for the `IPDCOperatorId` within the OSF SPP profile. The 18Crypt specification makes use of a string value (or anyURI) for this purpose. The string type is used for `IPDCOperatorId` also in the ESG [3] and CDP [6] specifications. The DVB Project maintains a central register for the `IPDCOperatorIds` related to standardized KMS. This open registration data base allows the provisioning of terminals with `IPDCOperatorId`'s and facilitate the process of service discovery for terminals when roaming. The registry contains for roaming signalling purposes both a 16-bit unsigned integer and a string value (or anyURI) of the `IPDCOperatorId`.

The value 0x0000 for the `IPDCKMSId` is reserved for non-encrypted services.

## 4.7 Rules of uniqueness

The `cell_id` that is used to uniquely identify a cell shall be unique within each `original_network_id` [4]. This implies that two networks (`network_ids`) within one `original_network_id` (one country) cannot use the same `cell_ids` for different cells.

A TS can be uniquely referenced through the path `original_network_id/transport_stream_id` [4]. In other words, a transport stream is unique in the scope of an `original_network_id`.

For each country a range of `network_ids` are allocated by DVB, therefore the `network_id` is unique in the scope of the `original_network_id`.

An IP Platform may span several Transport Streams within one or more DVB Networks. On the other hand, several IP Platforms may co-exist in the same Transport Stream. An IP Platform can be uniquely referenced with `platform_id`, or

the set of both `platform_id` and `network_id` in the case the `platform_id` is in the non-unique range. Global `platform_ids` are registered by DVB. Therefore, an IP Platform is or can be made globally unique.

Several ESGs may co-exist on the same IP Platform. `ESG_URI` and `providerURI` are globally unique.

The `IPDCOperatorId` is unique for each KMS, identified by the `IPDCKMSId` (mapped on a `CA_System_ID`). The `IPDCOperatorId` is assigned by the DVB Office in the case where the `IPDCKMSId` (or `CA_System_ID`) is in the range of the standardized KMS systems (values 0x0001 to 0x00FF) to ensure uniqueness of `IPDCOperatorId` within standardized `IPDCKMSId`. One or more `IPDCOperatorId`'s can be referenced in any ESG.

## 4.8 Mobility concepts

### 4.8.1 Basic handover concept

The basic mechanism for services access and handover within IPDC over DVB-H is to use the IP address (and the IP Platform) for the service, as provided by the ESG, and then via the INT find the global path(s) for the IP address: {`original_network_id`, `network_id`, `transport_stream_id`, `service_id`, `component_tag`} where the IP Stream of the service can be found. The NIT, together with `cell_id` on TPS bits, will provide the link between this global path and frequency/`cell_id`/location of a particular TS.

There are several reasons why a simplified handover approach, relying e.g. on `transport_stream_id` and/or `service_id` would not in general work.

Considering the variety in interpretations regarding the use and exact meaning of TS/`transport_stream_id`, one cannot e.g. be sure to find the desired IP Flow(s) even if the `transport_stream_id` is the same. The receiver cannot rely only on the combination {`original_network_id` / `service_id`}.

In the case the triplet {`original_network_id` / `transport_stream_id` / `service_id`} is identical, handover between `network_ids` would be possible.

In general, a `service_id` may contain several `component_tags`, with one elementary stream on each. Knowing just the `service_id` is not sufficient to find the IP Flow.

The `service_id` may even be different if the `transport_stream_id` is different. Finally, some interpretations may use the `service_id`, not to announce a particular IP Flow (or set of IP Flows), but as a label for 'IPDC services', without any guarantee regarding the actual IP Flow(s) being carried within the `service_id`.

As a matter of fact, the basic mechanism for bootstrapping, service access and handover is very robust against various interpretations of terminology and PSI/SI rules. If a receiver uses the basic mechanism and gets:

- the IP address (and IP Platform) of the desired IP Flow from the ESG;
- the global path(s), i.e. {`original_network_id`, `network_id`, `transport_stream_id`, `service_id`, `component_tag`} of the IP address from the INT;
- the `cell_id`/frequency/location of the desired `transport_stream_id` from the NIT (NIT actual and NIT other);
- the `cell_id` via TPS bits;
- the PID of the desired elementary stream, carrying the IP Stream, from the PAT/PMT on the target TS.

then service access and handover will work in any case.

Details on the TPS data used required for handover support with IP Datacast may be found in TS 102 470 [4] and TR 102 377 [7], clause 8.5.

Details on avoiding data loss when performing handovers may be found in TR 102 377 [7], clause 8.5.

### 4.8.2 Basic concept for roaming and special mobility cases

The basic idea is to use a parameter set ("roaming configuration") consisting of the three parameters `platform_id`, `ESG_URI`, and the pair of `IPDCOperatorId` and `IPDCKMSId`, in order to identify mobility cases beyond handover. These other cases comprise roaming as well as special mobility cases, which are neither roaming nor handovers.

The platform\_id and the network\_id are signalled within the PSI/SI tables. They are thus easily and quickly accessible.

The ESG\_URI, provider\_URI and providerID are signalled in the ESG bootstrap.

The IPDCOperatorId and IPDCKMSId are also signalled in the ESG bootstrap for roaming purposes in order to enable quick roaming partner discovery. A specification of this signalling (RoamingInformation Descriptor) is provided in Annex A.

## 5 Use cases

### 5.1 Handover use cases

#### 5.1.1 Overview of handover use cases

In this clause, different handover use cases are listed which may occur due to terminal mobility in a IP Datacast over DVB-H broadcast system. The handover use cases are distinguished based on usage of PSI/SI tables and TPS. Each handover use case requires the terminal to apply a strategy to maintain, whenever possible, service continuity (i.e. no user perceivable interruption of the IPDC service being consumed).

Table 1 summarizes the mobility use-cases for a terminal acquiring IP Flows from a given IP Platform.

**Table 1: Handover use cases**

Case	original_network_id change	transport_stream_id change	network_id change	cell_id / subcell_id change	Handover based on TPS and NIT (see note 1)	Handover based on INT, TPS and NIT (see note 1)
1				X	applicable	Applicable (see note 2)
2			X	X	applicable under condition (I)	applicable under conditions (I) (see note 3)
3		X		X	not applicable	applicable
4		X	X	X	not applicable	applicable under conditions (I) (see note 3)
5	X	X	X	X	not applicable	applicable under conditions (I) (see note 3)

NOTE 1: See clause 6.2 and DVB-H IG TR 102 377 [7].  
 NOTE 2: INT not necessary.  
 NOTE 3: This is possible since the INT shall announce IP Flows also on other networks.

**Condition (I):** Target NIT is available (by NIT\_Other or other means).

Figure 3 graphically highlights the use-cases of Table 1.

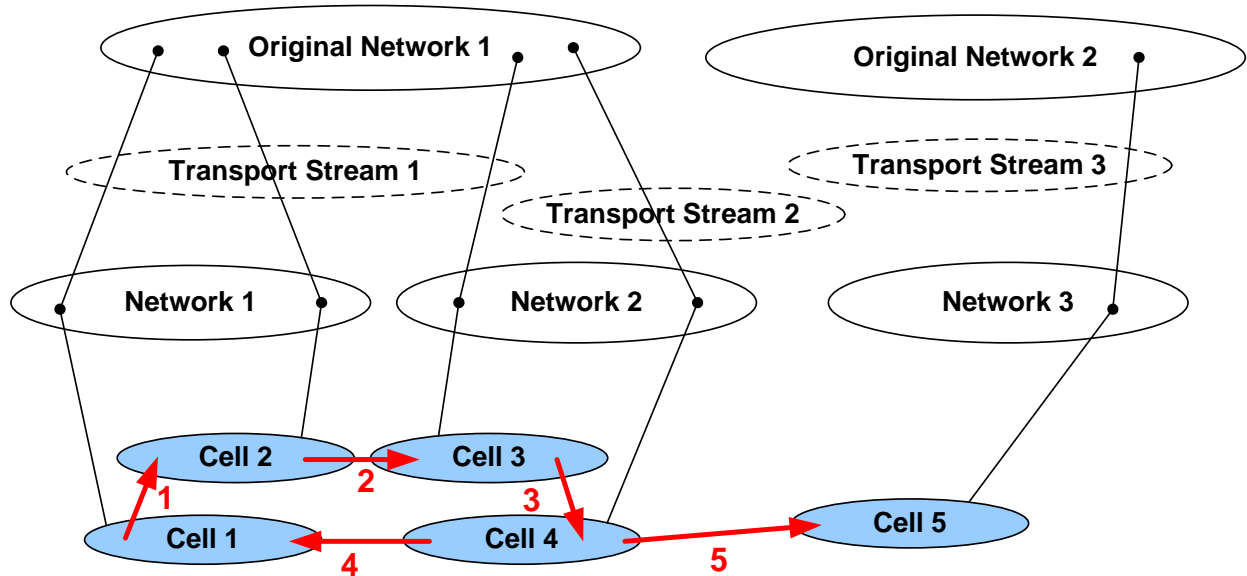

Figure 3: Handover use cases 1 to 5

## 5.1.2 Detection of alternative service reception parameters

### 5.1.2.1 Handover Use Case 1: Change of cell\_id or subcell\_id

In this scenario, the alternative services reception parameters could be found in the NIT (actual) as follows:

- i) The terminal checks the `other_frequency_flag` in the `terrestrial_delivery_system_descriptor` in the NIT of the actual network to determine whether other frequencies are in use. In this scenario, this flag will show as true.
- ii) The terminal could acquire information on all other frequencies and their cell (sub cell) ids by decoding the `cell_frequency_link_descriptor`.
- iii) The terminal could acquire information on the geographical location of such cells and the geographical location of the current cell by decoding the `cell_list_descriptor`.

Based on this, the terminal could check the availability of the signals of the cells where the terminal is located and select the ones with the best quality as candidates to handover to.

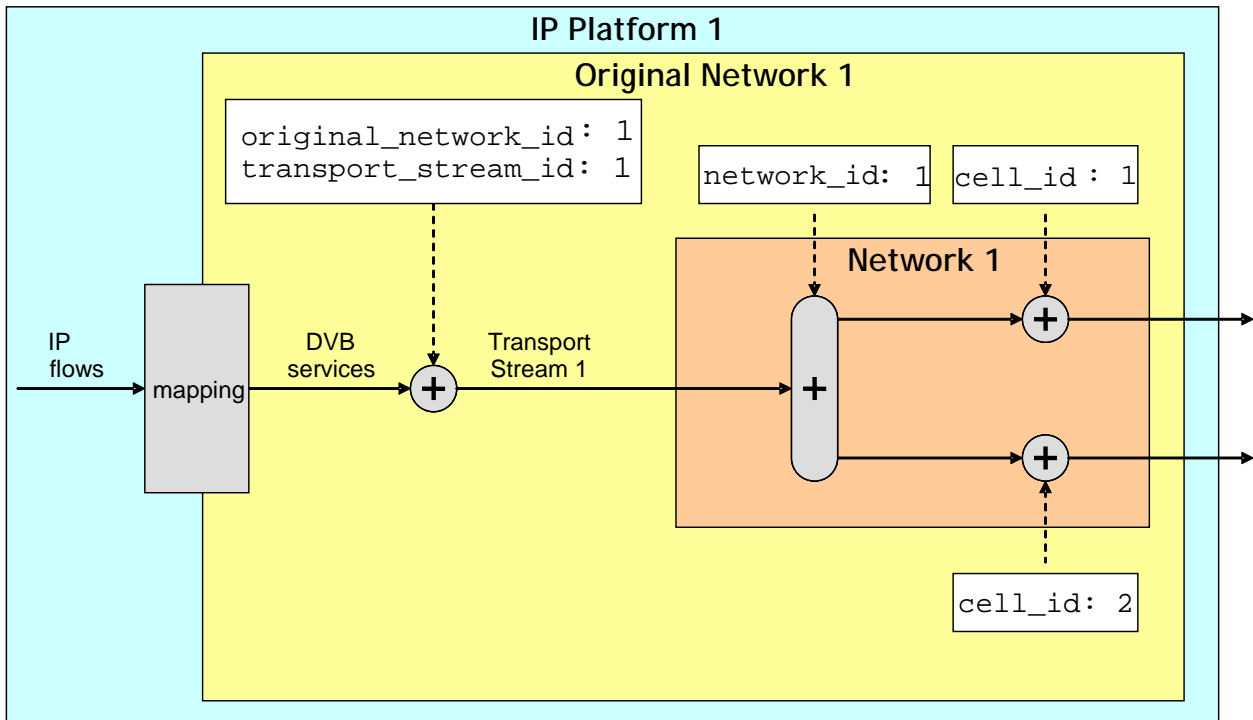

Figure 4: Handover scenario 1

#### 5.1.2.2 Handover Use Case 2: Change of cell\_id and network\_id

In this scenario, the terminal can determine other networks in which the same TS and therefore the same IP Flow, is available.

If two TSs have the same TS\_id and original\_network\_id, it means they are identical. The terminal needs to find the TS that has the same TS\_id and original\_network\_id from the NIT(other), and the corresponding reception parameters from the NIT(other).

- i) The terminal could find the TS that has the same TS\_id and original\_network\_id from the NIT(other).
- ii) The terminal could acquire information on all the frequencies and their cell\_id's for this TS from the cell\_frequency\_link\_descriptor in NIT(other).
- iii) The terminal could acquire information on the geographical location of such cells and the geographical location of the current cell by decoding the cell\_list\_descriptor from NIT(other).

Based on this, the terminal could check the frequencies carrying the same TS in the neighbouring cells belonging to another network and select the one with the best quality.

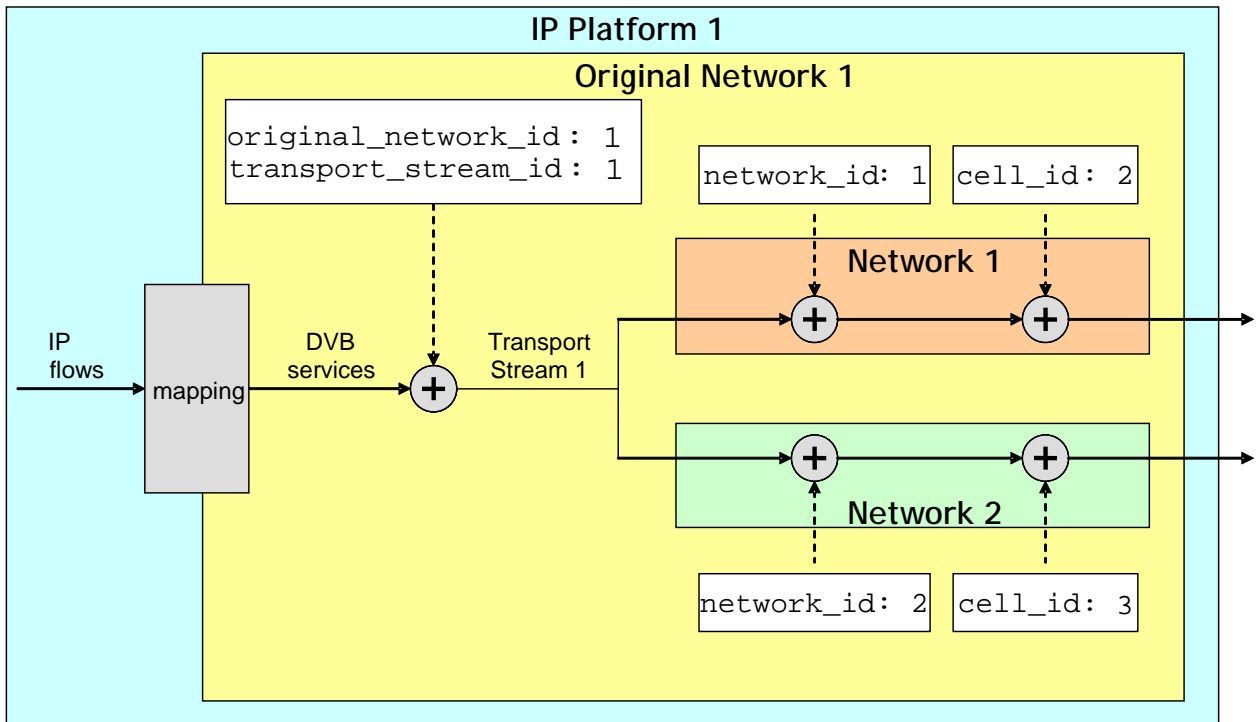

Figure 5: Handover scenario 2

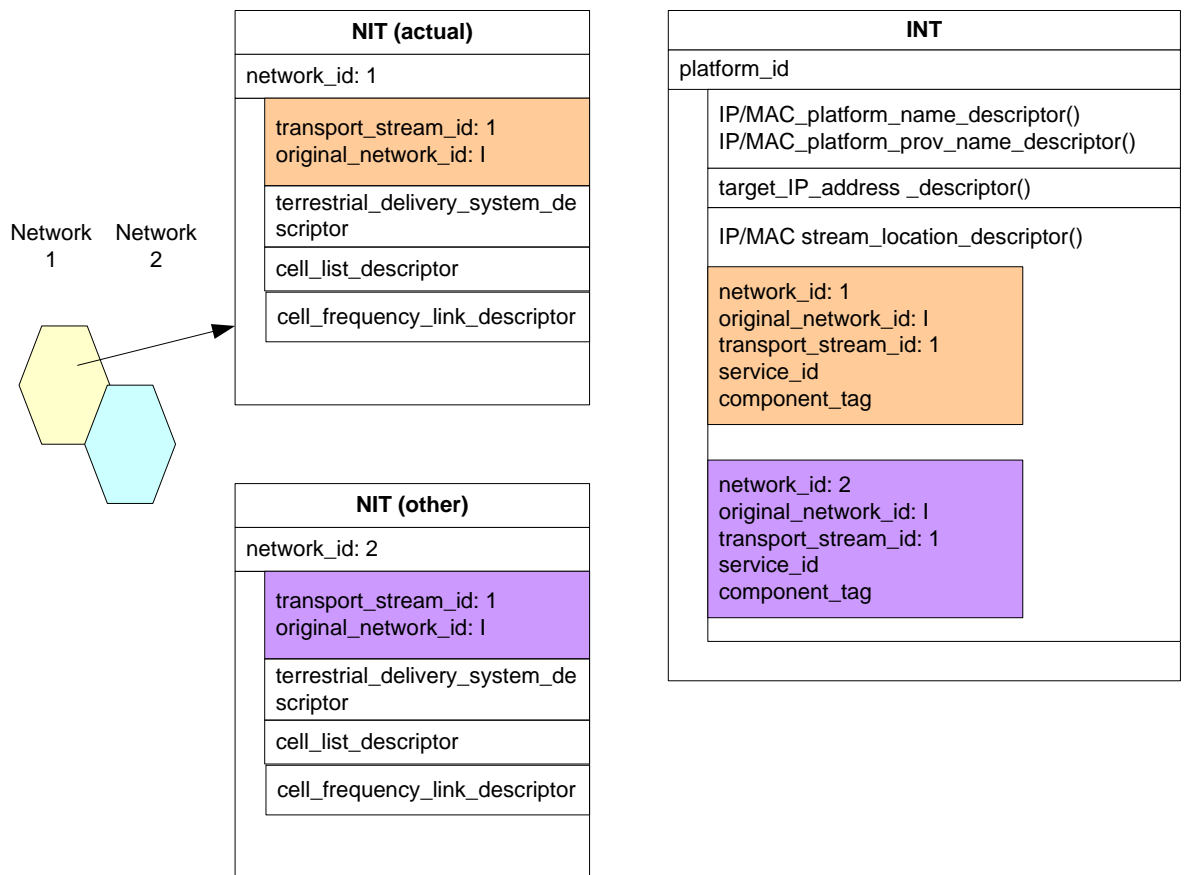

Figure 6: PSI/SI support for handover scenario 2

### 5.1.2.3 Handover Use Case 3: Change of cell\_id and transport\_stream\_id

In this scenario, the terminal could find the same IP Flow in another TS from the INT sub-table (i.e. as part of the same IP Platform), and corresponding reception parameters in NIT(actual):

- i) The terminal could find out each TS that carries the same IP Flow by decoding the IP/MAC stream\_location\_descriptor in the INT sub-table.
- ii) The terminal could acquire information on all the frequencies and their cell\_ids for these TSs by decoding the cell\_frequency\_link\_descriptor in NIT(actual).
- iii) The terminal could acquire information on the geographical location of such cells and the geographical location of the current cell by decoding the cell\_list\_descriptor from the NIT(actual).

Based on this, the terminal could check the availability of the signals of the cells accessible where the terminal is located and select the ones with the best quality as candidates to handover to.

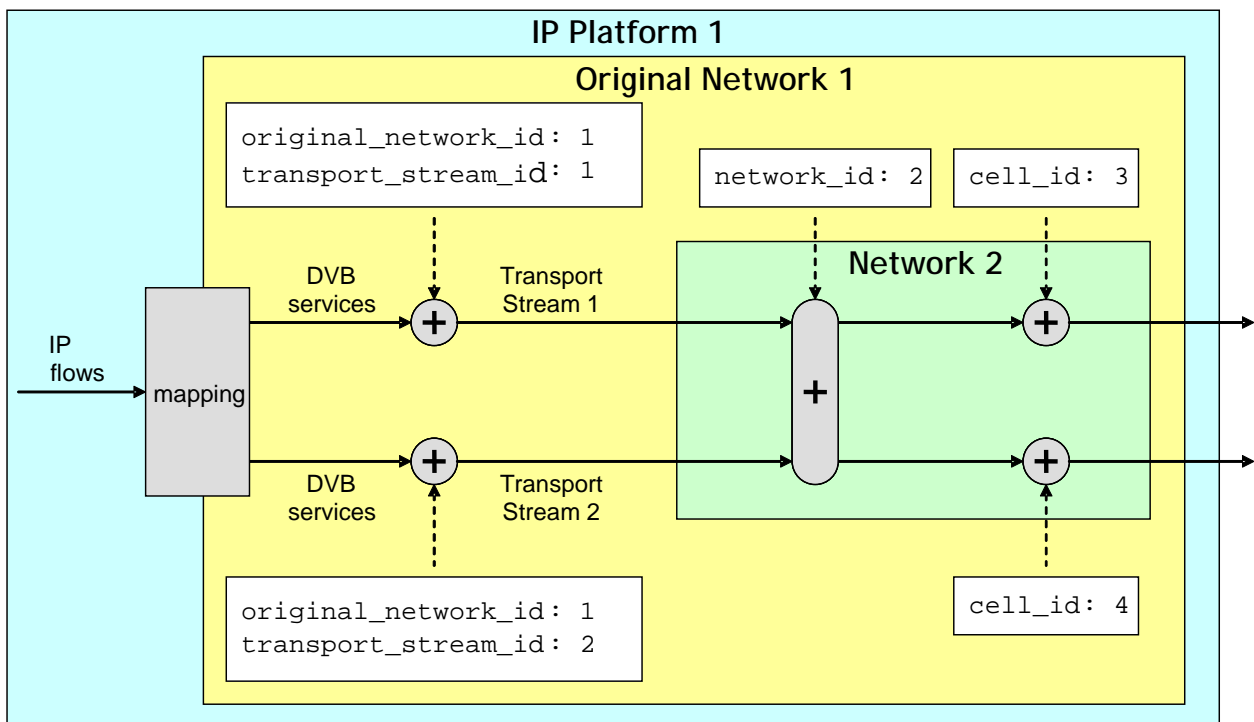
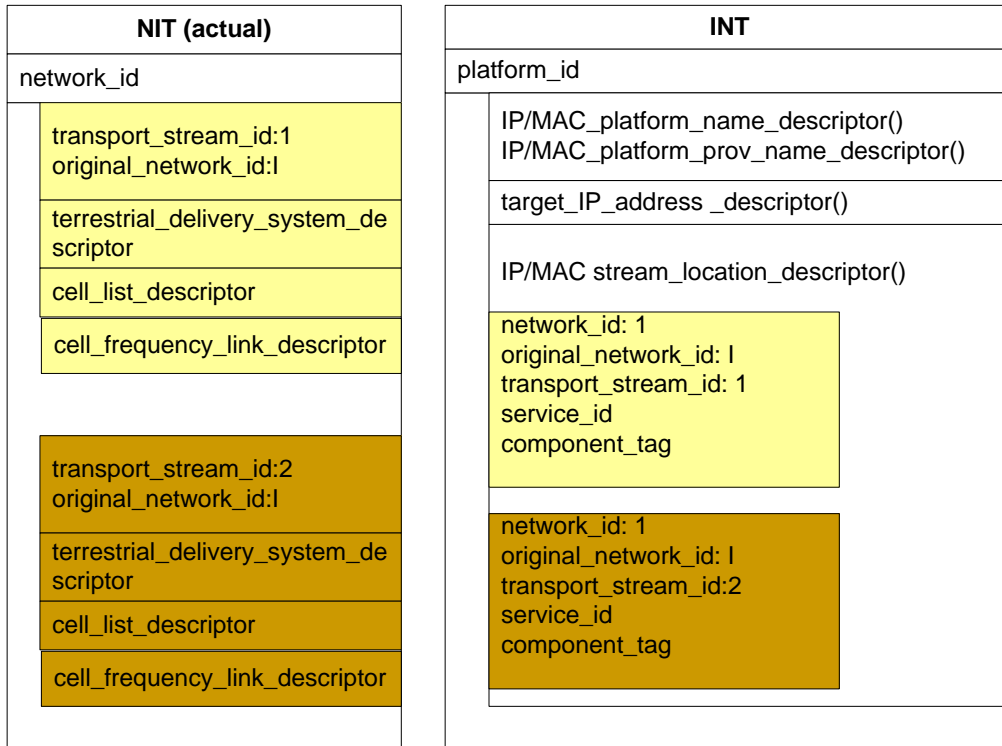

Figure 7: Handover scenario 3



**Figure 8: PSI/SI support for handover scenario 3**

#### 5.1.2.4 Handover Use Case 4: Change of cell\_id and network\_id and transport\_stream\_id

In this scenario, the terminal can determine other networks in which other TSs carrying the same IP Flow are available.

The terminal could find out that the same IP Flow is available on another TS from the INT sub-table. From NIT(other), the terminal can get information on other networks carrying other TS's with the same IP Flow:

- i) The terminal could find each TS that carries the same IP Flow from the IP/MAC stream\_location\_descriptor in the INT sub-table.
- ii) The terminal could acquire information on all the frequencies and their cell\_id's for these TSs from the cell\_frequency\_link\_descriptor in NIT(other).
- iii) The terminal could acquire information on the geographical location of such cells and the geographical location of the current cell by decoding the cell\_list\_descriptor in NIT(other).

Based on this, the terminal could check the frequencies carrying the same TS in the neighbouring cells belonging to another network and select the one with the best quality.

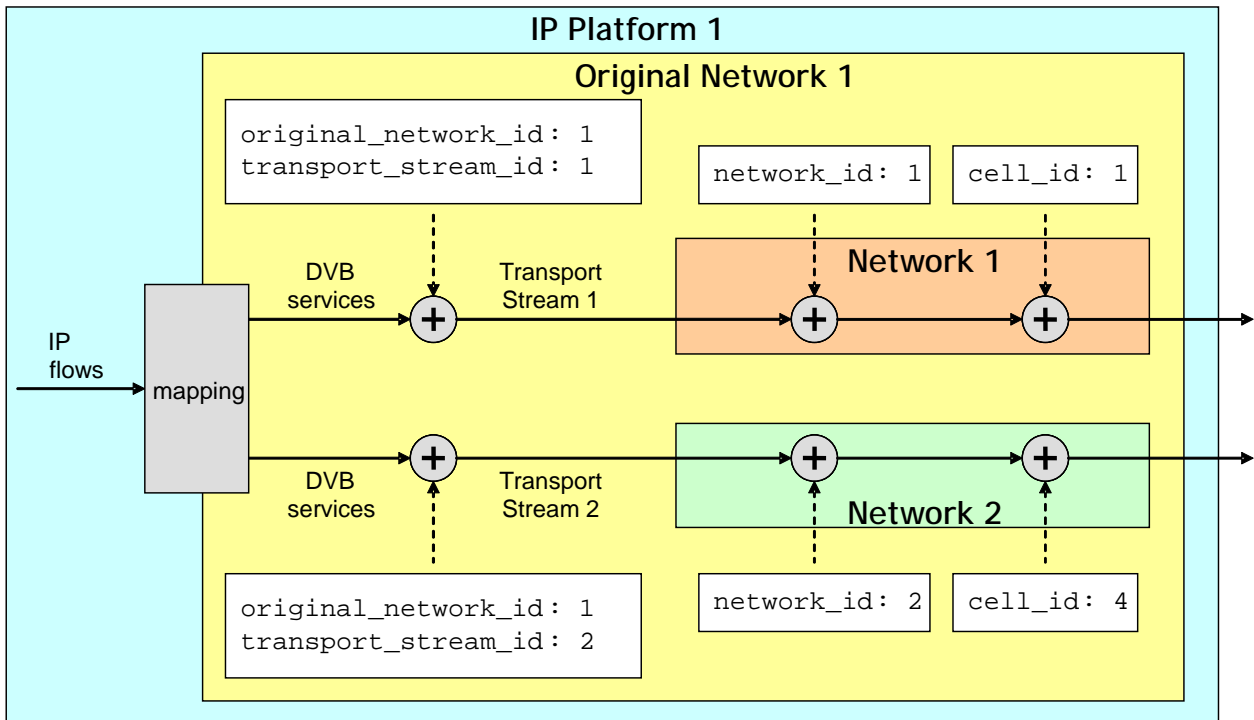

Figure 9: Handover scenario 4

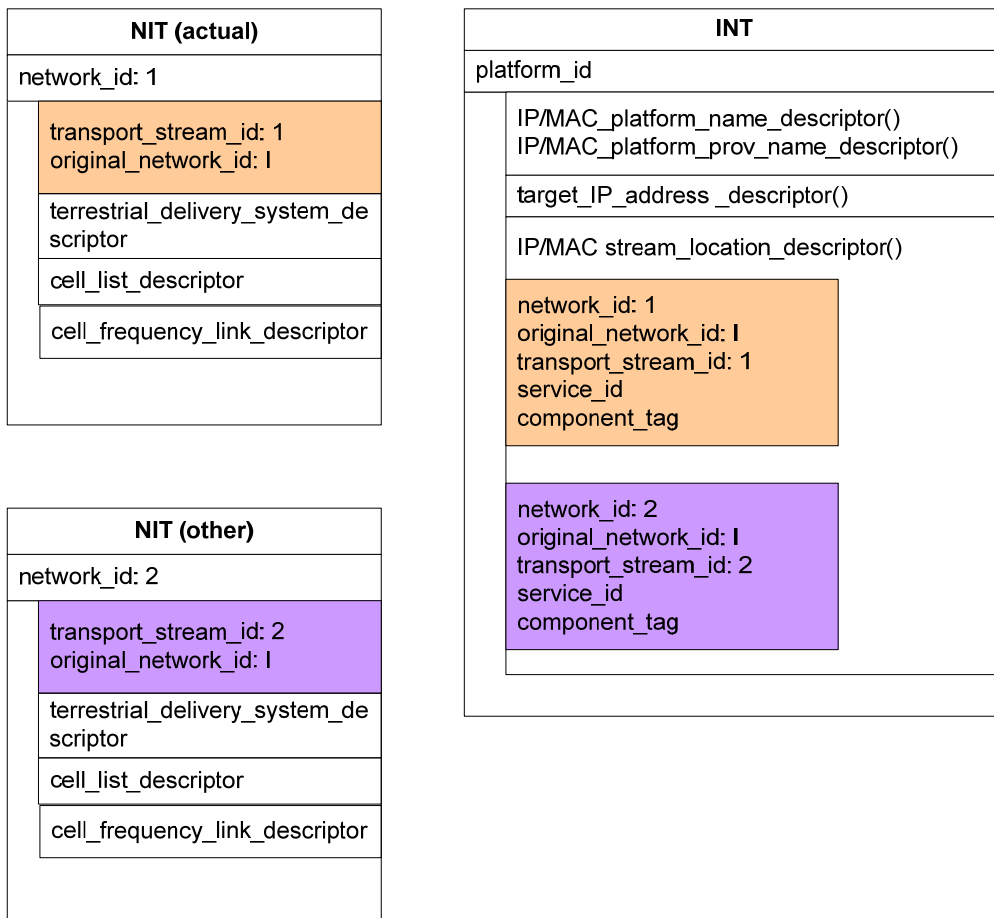

Figure 10: PSI/SI support for handover scenario 4

### 5.1.2.5 Handover Use Case 5: Change of Original Network

The terminal could find the same IP Flow in another TS from the INT sub-table that also carries information for other networks where the same IP Platform is available. Corresponding reception parameters are to be found in the NIT(other):

- i) The terminal could find each TS that carries the same IP Flow from the IP/MAC stream\_location\_descriptor in the INT.
- ii) The terminal could acquire information on all the frequencies and their cell\_ids for these TSs from the cell\_frequency\_link\_descriptor in NIT(other).
- iii) The terminal could acquire information on the geographical location of such cells and the geographical location of the current cell by decoding the cell\_list\_descriptor in NIT(other).

Based on this, the terminal could check the frequencies carrying the same TS in the neighbouring cells belonging to another network and select the one with the best quality.

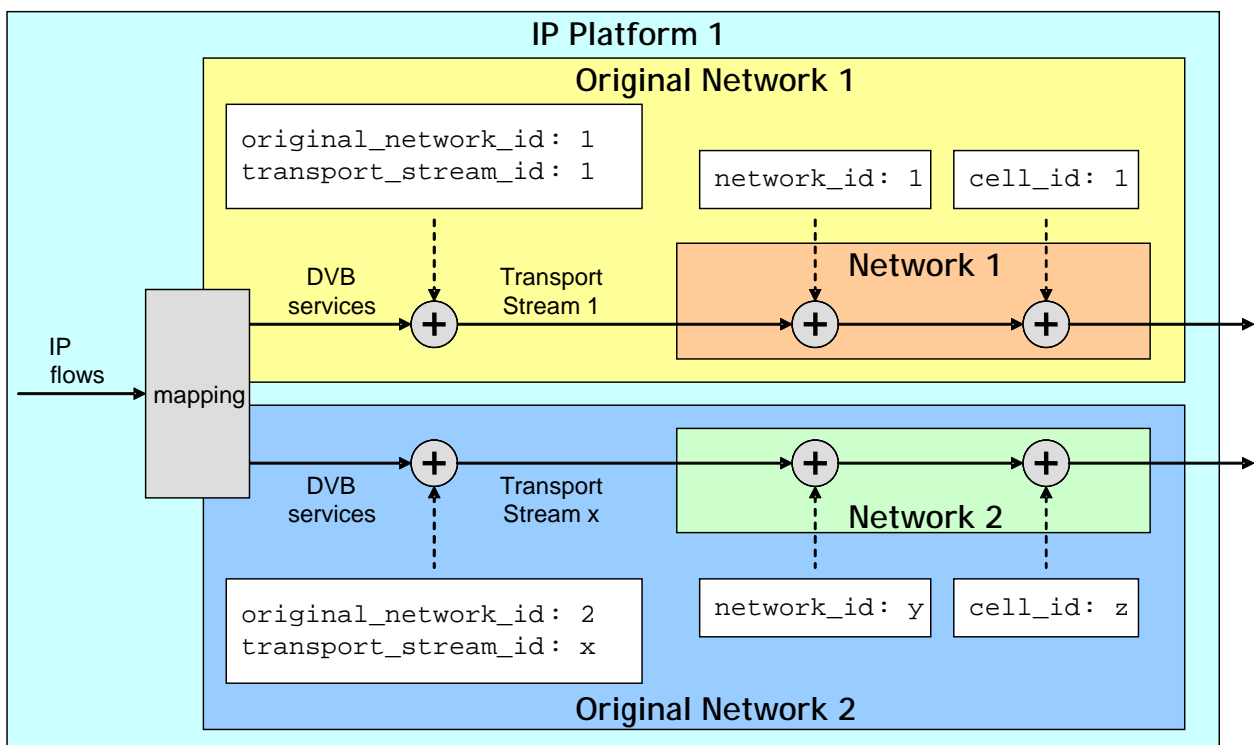

Figure 11: Handover scenario 5

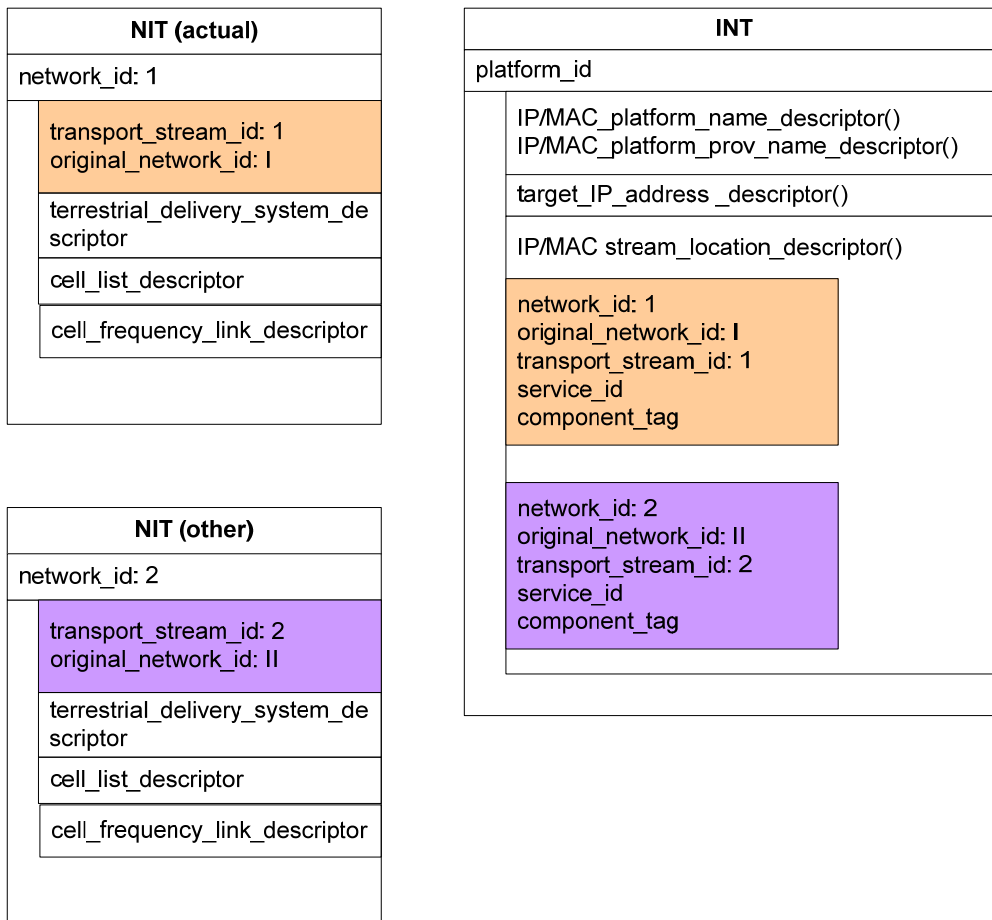

Figure 12: PSI/SI support for handover scenario 5

## 5.2 Roaming and special mobility use cases

### 5.2.1 Overview of Roaming and special mobility use cases

There are 7 use cases out of which 5 are described in the following section, the two remaining are not considered valid.

Table 2: Roaming and special mobility use cases

Case	Change of			Comment
	Physical Delivery Platform	ESG	IPDC Operator	
	platform_id (if not unique, also network_id)	providerURI and providerID (IPDC phase 1)  ESG_URI (IPDC phase 2)	IPDCOperatorId and/or IPDCkMSId	
1			X	
2		X	X	
3	X	X	X	
4		X		
5	X	X		
6	X			<i>ESG supposed to change with change of IP Platform. Should be treated by the terminal as use case 5.</i>
7	X		X	<i>ESG supposed to change with change of IP Platform. Should be treated by the terminal as use case 3.</i>

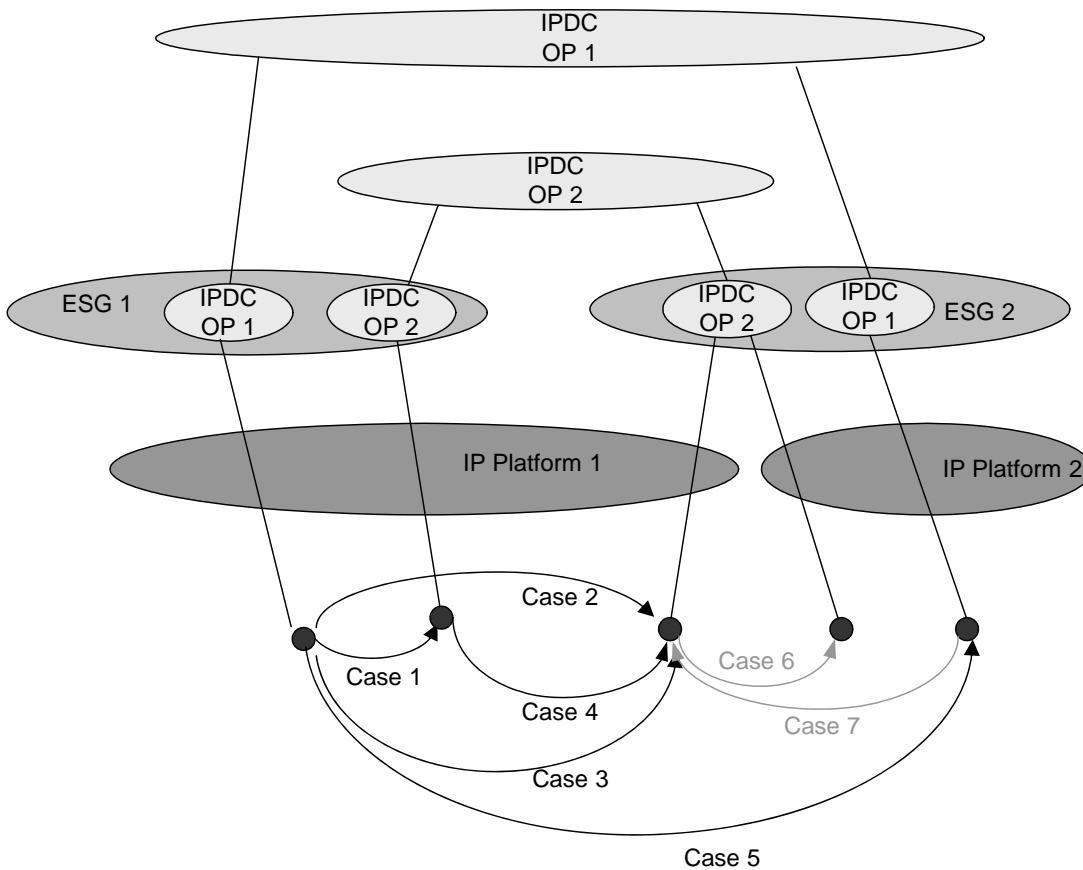
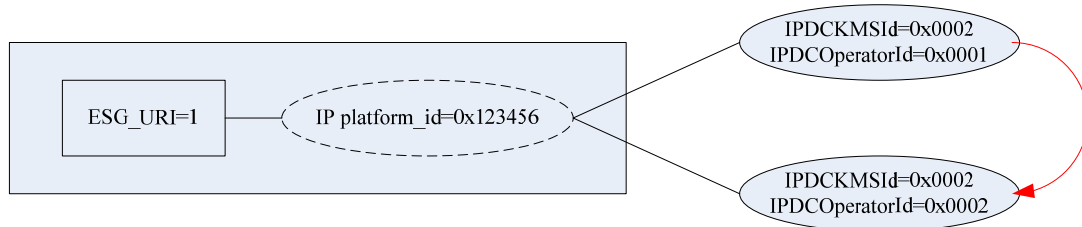

Figure 13: Roaming and special mobility use cases

## 5.2.2 Description of use cases

### 5.2.2.1 Roaming Use Case 1

Roaming use case 1 is shown in figure Figure 14. The terminal changes the service reception from IPDC Operator 1 to IPDC Operator 2 in the same ESG and IP Platform.



**Figure 14: Roaming use case 1**

#### Characteristics of this use case:

- There are two different IPDC Operators in the same ESG and IP Platform.
- Some services may be owned by both IPDC Operators, while others may belong to one IPDC Operator only.

### 5.2.2.2 Roaming Use Case 2

Roaming use case 2 is shown in Figure 15. The terminal changes the service reception from the IPDC Operator1 in ESG 1 to IPDC Operator 2 in ESG 2, but still on the same IP Platform.

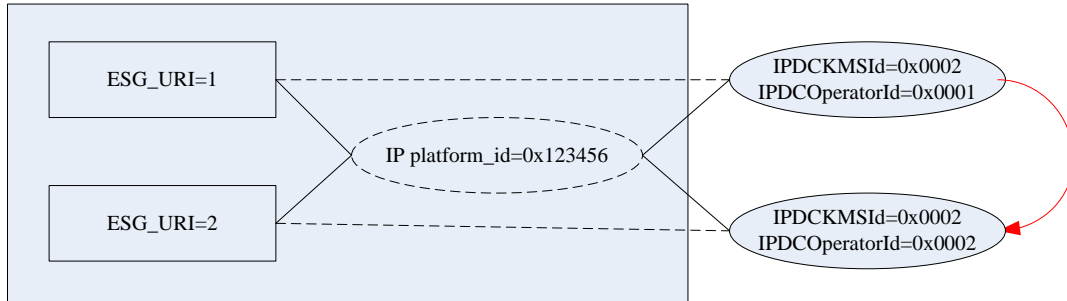

**Figure 15: Roaming use case 2**

#### Characteristics of this use case:

- Different IPDC Operators in different ESGs use the same IP Platform.
- The ESGs may contain common services, while others may differ.

### 5.2.2.3 Roaming Use Case 3

Roaming use case 3 is shown in Figure 16. The terminal changes the service reception from IPDC Operator 1 in ESG 1 on the IP Platform 1 to IPDC Operator 2 in ESG 2 on the IP Platform 2.

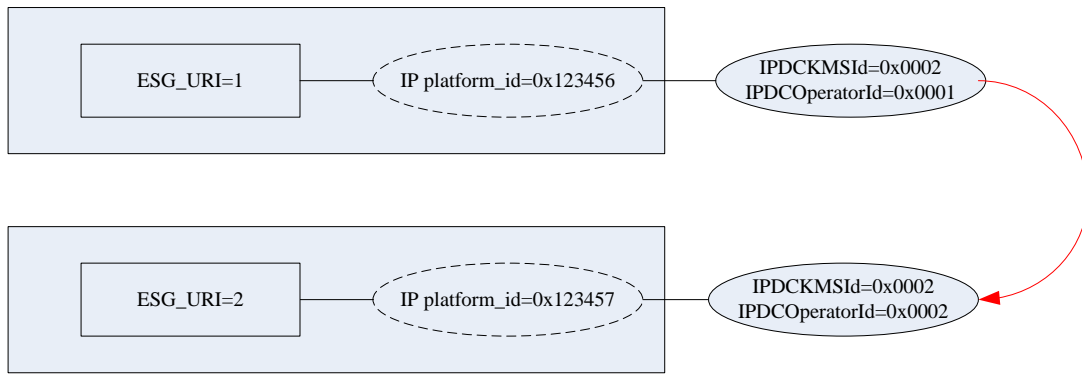

**Figure 16: Roaming use case 3**

**Characteristics of this use case:**

- Each IPDC Operator uses a dedicated ESG and IP Platform.
- The ESGs may contain common services, while others may differ.

#### 5.2.2.4 Special Mobility Use Case 4

Special mobility use case 2 is shown in Figure 17. The terminal changes the service reception from ESG 1 to ESG 2 on one IP Platform and on one IPDC Operator.

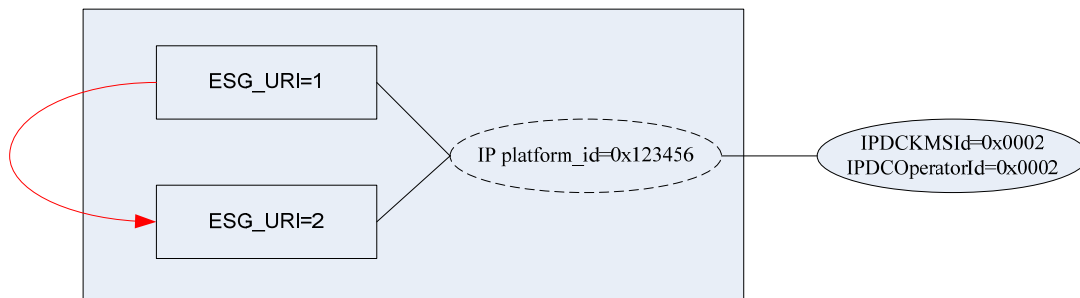

**Figure 17: Special mobility use case 4**

**Characteristics of this use case:**

- On one IP Platform, two different ESGs describe IPDC services of the IPDC Operator.
- The ESGs may contain common services, while others may differ.

#### 5.2.2.5 Special Mobility Use Case 5

Special mobility use case 5 is shown in Figure 18. The terminal changes the service reception from ESG 1 in IP Platform 1 to ESG 2 in the IP Platform 2, but still on the same IPDC Operator.

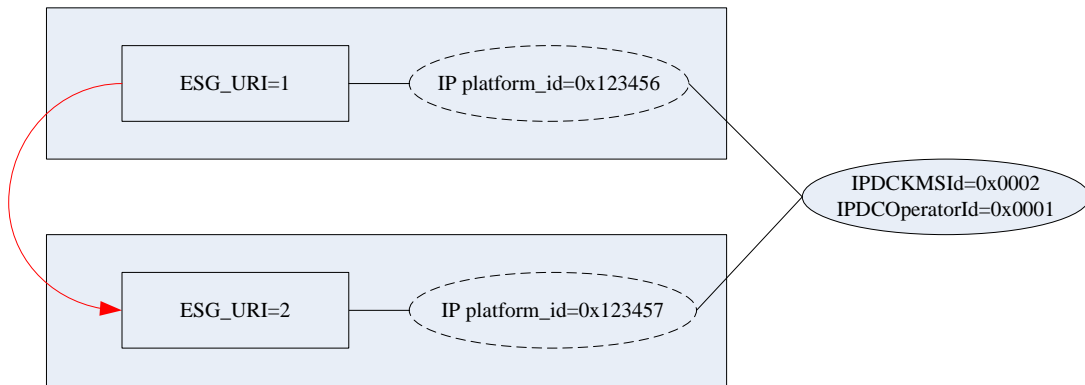

**Figure 18: Special mobility use case 5**

**Characteristics of this use case:**

- One IPDC Operator uses two different ESGs on two IP Platforms.
- The ESGs may contain common services, while others may differ.

## 6 Terminal behavior

### 6.1 General mobility procedure

In the case the reception quality of the currently consumed DVB-H signal decreases, a terminal should try to continue service reception by performing a handover to an alternative signal. However, a handover with service continuation is only possible in the case that an alternative signal exists where the Home IPDC Operator, the Home ESG and Home IP Platform are present on an alternative. The implementation guidelines for handovers are given in section 6.2.

In the case that the Home IP Platform is still present but either the Home ESG or Home IPDC Operator are not, the terminal can still try to perform service continuation. In the case that the handover fails or the Home IP Platform is not present, service continuation will typically not be possible. The terminal should in that case try to access other services on the alternative signal. The implementation guidelines for these roaming and special mobility cases are given in section 6.3.

### 6.2 Handover implementation guidelines

#### 6.2.1 General procedure

A handover consists of several high-level steps which are listed below.

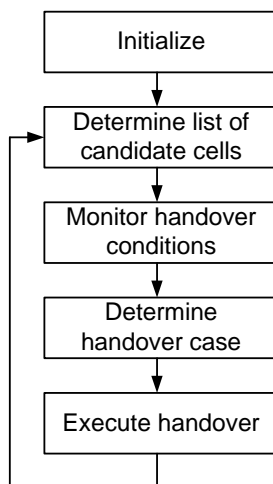

**Figure 19: High-level handover procedure**

- 1) Initialization:
  - Within the initialization phase, the terminal has to acquire a 'start frequency' used for DVB-H reception. This frequency may, for example, be acquired by a signal scan or by provisioning the terminal accordingly.
  - At least the ESG and possibly additional services have to be received, otherwise the execution of a handover does not make sense.
- 2) Determine list of candidate signals:
  - Within this phase, the terminal has to acquire parameters of possible alternative signals by making use of information in the PSI/SI tables. Specifically, the NIT and INT tables have to be analyzed.
  - The terminal generates a list of a number of candidate signals suitable for a handover.
- 3) Determine possible handover cases:
  - Within this phase, the handover case(s) of the candidate signal(s) is (are) determined.
- 4) Monitor handover conditions:
  - The terminal monitors the signal quality (e.g. signal strength, SNR, error rates, etc.) of the current signal and candidate signals
  - The terminal generates a list of candidate signals (best to worse) in order to select the best handover candidate.
- 5) Execute handover:
  - Finally, the handover may be executed.
  - Afterwards, the terminal continues with step 2.

## 6.2.2 Initialization

In order to obtain a start frequency, a signal scan may be used, or alternatively, the terminal may be provisioned with a certain start frequency.

The signal scan is a process which can be said to provide the foundation for the service discovery and handover. The run of the signal scan is implementation specific. However, due to the fact that NIT other is not mandatory for the network, a receiver might want to run the signal scan occasionally in order to be up to date with the new networks which might become available, especially if the receiver is moving long distances.

In the signal scan, the receiver scans signals within the selected frequency range, which may be exhaustive or include only a subset of the all possible frequencies. The used frequency offset may also cover all possible bandwidth

possibilities or it may be determined based on the information of the current location, if available. The steps involved in the general signal scan dataflow are described below.

- Step 1: The receiver attempts to synchronize to the signal within the given frequency range.
- Step 2: Prior to the synchronization to the signal completely, receiver may have TPS lock.
- Step 3: In the case TPS lock is achieved, it is inspected whether the DVB-H indicator within TPS bits indicates that the signal carries DVB-H services. If the signal is a DVB-H signal, the receiver attempts to synchronize to the signal. Otherwise the procedure continues to step 5.
- Step 4: In case the synchronization is successful, receiver starts to seek and receive the PSI/SI.
- Step 5: In case there are no more signals to scan, the procedure is exited. Otherwise the scan is continued from the next possible frequency. The list of possible frequencies, which are to be scanned, may be limited based on information carried within NIT.

### 6.2.3 Determine list of candidate signals

As the next step to prepare a handover, the terminal generates a list of neighbouring cells. By using information from the SI, it is possible to extract information on the location of the current cell and also of other cells. The necessary process for this is discussed in detail in TR 101 211 [8] and is similar to DVB-T handovers.

### 6.2.4 Determine handover case

On the basis of information in the INT, the terminal is able to find parameters of alternative signals ("handover candidates") from adjacent cells that also carry the currently consumed IP Flow(s). For each of these handover candidates, the terminal needs to evaluate the handover case to access the new signal. The figure below shows how to determine the handover case that is valid for a certain handover candidate. The handover cases are discussed in detail in clause 5.1 of the present document. Based on the information in clause 5.1, a handover algorithm suitable for the present handover case may be chosen. The algorithms themselves are described in clause 6.2.5.

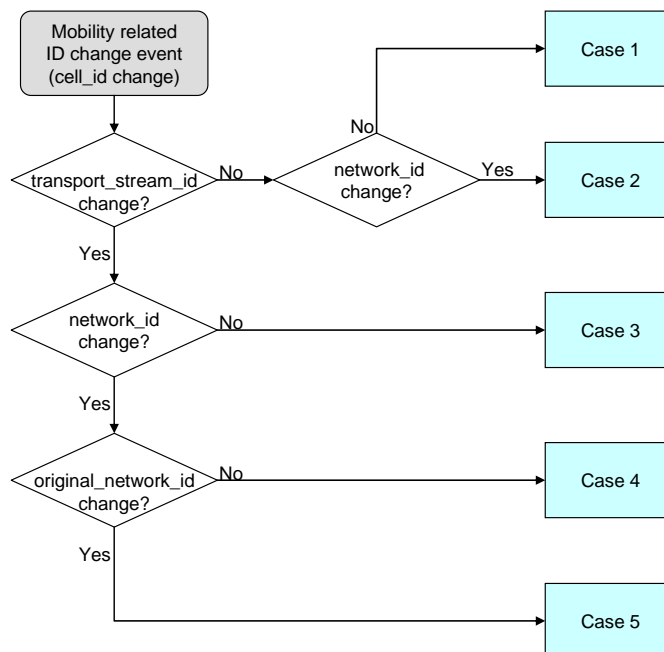

Figure 20: Decision on handover case

### 6.2.5 Monitor handover conditions

A handover may be advantageous if the reception conditions are (or may be assumed to be) better when the terminal would change reception to an alternative signal that also carries the IP Flow(s) currently being received. The exact criteria used for this purpose are up to implementation and no binding algorithms have been specified.

There are a number of parameters which may be used in the decision process. A number of these parameters are outlined in detail below.

In order to avoid ping-pong effects (meaning the terminal changing between two signals unnecessarily frequently), a hysteresis should be used for any criteria.

There are two separate procedures that must be done during the monitoring phase.

First, the existing signal quality must be monitored in order to evaluate the quality of the signal on which the current IP Flow(s) is being consumed. If the current signal-quality is "good enough", handover will not be necessary.

Second, any viable alternative signals must be evaluated, so that if handover is to take place the "best" alternative signal available will be selected.

If there is not a "better" alternative signal available, then regardless of the condition of the current signal, handover should not be attempted.

### 6.2.5.1 Parameters that may be used in monitoring and evaluating

For DVB-H receivers, there are many parameters that may be monitored and subsequently used in determining (a) when handover should take place and (b) the best alternative signal to handover to.

These parameters include, but are not limited to, the following:

- 1) RSSI (Received Signal Strength Indicator):
  - The RSSI gives the full spectrum power available at the antenna, over an entire spectrum range.
  - RSSI is a measurement of the received radio signal strength (an energy measurement, not necessarily a quality measurement).
- 2) DP (Derived Power):
  - When the signal is processed by the receiver, there will be signal-conditioning performed on that signal. In this signal-conditioning stage, there will be a number of filtering and gain stages applied.
  - As a result of applying some or all of these stages, it will be possible to derive a power level for the received "wanted signal".
  - This derived power level may be known as the Derived Power, and it is a good early indicator of the possible quality-of-signal available.
  - This indicator does not distinguish between the signal power and the noise power.
- 3) SNR (Signal to Noise Ratio):
  - The SNR is the ratio of the (wanted) signal power to the noise power that is corrupting it: it compares the power level of the desired signal to the power level of noise.
  - This indicator will be available after the signal conditioning has completed in the signal-conditioning stage.
  - This value is a good early indicator of the quality-of-signal available.
- 4) BER (Bit Error Rate):
  - The Reference BER is defined as:  $BER = 2 \times 10^{-4}$  after Viterbi decoding in the receiver.
  - This criterion corresponds to the DVB-T standard defined Quasi Error Free (QEF) criteria, causing "less than one uncorrected error event per hour" [9].
  - It should be noted that the Reference BER is considered to be an un-suitable criterion in the mobile environment due to fast channel variations.
  - In mobile cases, the Reference BER criteria may give unstable values which could result in an underestimation of DVB-H capabilities.

## 5) Packet Error Ratio (PER):

- The PER is measured as the number of non-correctable RS packets that were received, over the total number of RS packets received. The rule-of-thumb subjective-failure value, as defined in [9], is considered to be  $1 \times 10^{-4}$ :
  - a) Picture Failure Point (PFP).
 

The picture failure point is defined in [9] as the minimum C/N value for more than 1 TS-packet error in 10 seconds.
  - b) Subjective Failure Point (SFP) in mobile reception.
 

The SFP is defined in [9] as a Packet Error Rate (PER) of  $1 \times 10^{-4}$  after the RS-decoder at the demodulator TS-output.

The SFP corresponds to: "On average, one visible error in the video, during an observation period of 20 seconds".
- The observation period [9] for the PER-measurement should be at least 800,000 TS-packets (corresponding to roughly 2 mins with 16QAM CR=1/2 GI=1/4 mode).

## 6) MFER (MPE-FEC Frame Error Rate):

- The MFER criterion detects errors after complete demodulation and decoding: i.e. after the Viterbi, Reed-Solomon and MPE-FEC steps have been completed.
- MFER is the ratio of the number of non-correctable frames over the number of received frames [9]. A minimum of 100 received frames is recommended. A very small change in C/N will result in a large change in MFER.
- A threshold value known as MFER5 is considered to be the 'limit of an acceptable quality of image' [9]. MFER5 means that 5 % of the total number of received frames had non-correctable errors.
- If a DVB-H signal has degraded to an MFER5 level, then the quality of the service being offered has already degraded too much. When detecting signal-degradation, MFER1 would be a better threshold value to use.

For a typical DVB-H receiver, a pictorial overview of where each of these measurements can be taken is shown in Figure 21.

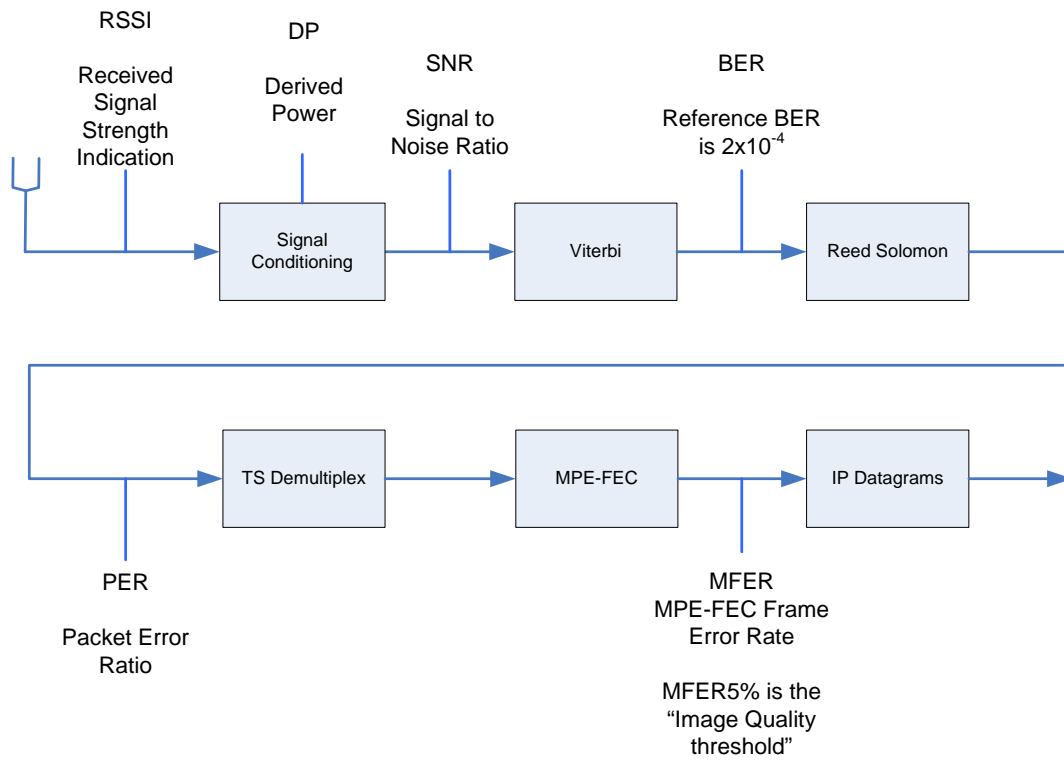

**Figure 21: Parameters for handover decision**

Each of these parameters has advantages and disadvantages associated with it, and some are more suitable for use than others.

**Table 3: Possible parameters for handover decision making**

Parameter:	Advantages:	Disadvantages:
RSSI	Can be measured quickly. Gives a good early indication of poor reception conditions. No need to demodulate a transport stream to estimate RSSI.	Supplies an estimate for the energy available in the band, not the quality of the signal. Does not give any indication of bit- or byte-errors, and so does not provide deterministic QoS metrics.
DP	Can be measured quickly. Gives a good early indication of poor reception conditions. No need to demodulate a transport stream to estimate DP.	May not be available on some implementations. Supplies an estimate of the "wanted" energy received: but this estimate does not distinguish between the signal power and the noise power. Does not give any indication of bit- or byte-errors, and so does not provide deterministic QoS metrics.
SNR	Can be measured quickly. Gives a good early indication of reception conditions. Gives a relative signal quality. No need to demodulate a transport stream to estimate SNR.	Does not give any indication of bit- or byte-errors, and so does not provide deterministic QoS metrics.
BER	Gives a good indication of current signal quality.	Needs to demodulate a transport-stream. Not reliable in once-off measurements. Can change very quickly in DVB-H environments.
PER	Good metric to monitor and use for deciding when the signal quality is degrading. Provides good granularity on signal-quality conditions over time.	Needs to demodulate a transport-stream. Needs to be measured over a period of time (e.g. 10 s).
MFER	May be a good metric to use for detecting an urgent need for handover. Provides good granularity on signal-quality conditions over time.	Needs to demodulate a transport-stream. Needs to be measured over a period of time (e.g. 2 min). When problems are detected at the MFER level, it may be already too late to perform seamless handover.

### 6.2.5.2 Monitor existing signal quality

When monitoring the signal-quality of a DVB-H signal, a combination of the SNR, PER and MFER metrics could provide good QoS information.

In order to use the PER and MFER metrics, a pre-requisite is that the IP Flow(s) is successfully being consumed over a period of time (e.g. at least 10 s for PER; at least 2 mins for MFER).

Once the IP Flow(s) is stable, these metrics can be updated and monitored as time progresses.

The PER metric can be used to give an indication of a slowly degrading QoS.

It should be possible to set two threshold values: When the PER reaches the first threshold, this could trigger the receiver to start looking for a viable alternative signal, while still providing the service on the existing one (figure 16, decision point A).

If the second threshold value is reached, then handover to the best alternative signal should take effect (Figure 22, decision point B): note that this handover will only make sense if the "best alternative" signal is both available and quantifiably better than the current signal (Figure 22, decision points C and D).

The SNR values can be compared and if there is a sufficient positive differential between the two values, then handover should take place (Figure 22, decision point D).

In addition to using the PER metric with two threshold values, the MFER metric can also be monitored. If the MFER is seen to change dramatically, then the signal quality could be considered to be degrading quickly: perhaps too quickly to wait for a second trigger value in order to seek handover to a better signal.

In this case, the receiver should compare the existing SNR value to the SNR value of the "best alternative" signal, and if there is a sufficient positive differential between the two values, then handover should take place.

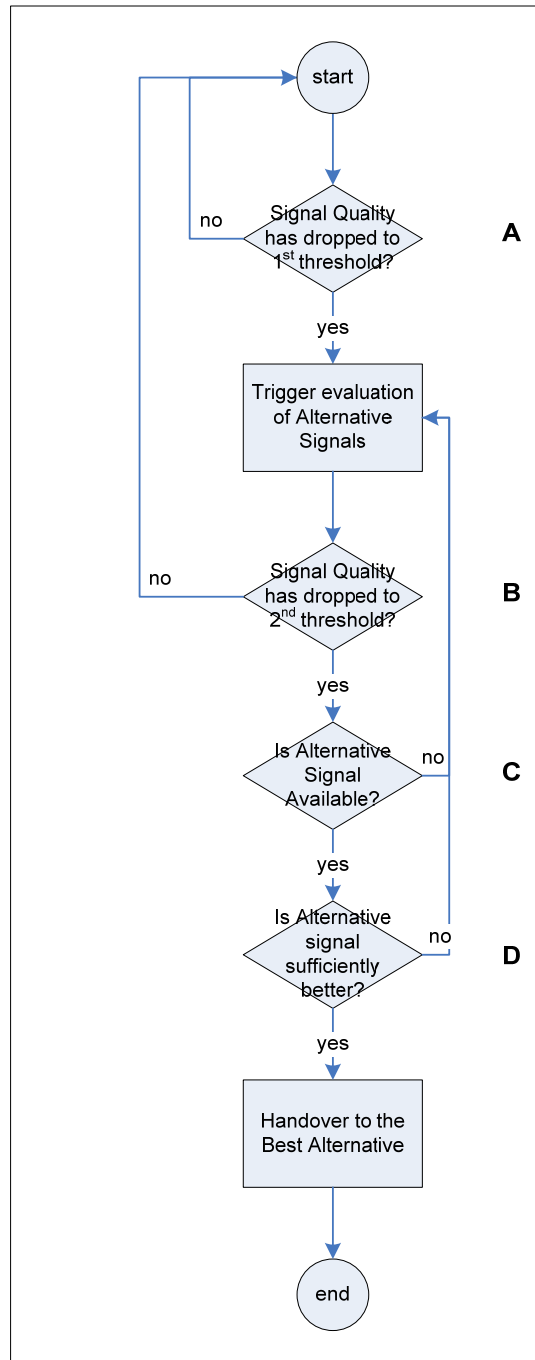

**Figure 22: Monitor existing signal quality**

### 6.2.5.3 Evaluate alternative signal quality

A pre-condition of this step, is that there is a list of possible alternative-signal candidates available. This pre-condition will be satisfied by following step 2 in clause 6.2.1.

It is reasonable to assume that the off-time between bursts will be in the order of 2 s. The off-time may be much longer than this (i.e. 4 s or more [10]), but 2 s is a good rule-of-thumb to use for practical DVB-H network deployments.

Any measurements that need to take place during this evaluation cycle must take place in the off-time between bursts.

The TPS carriers that are available in each DVB-H symbol carry information about the channel-coding, modulation and cell identification. These bits can be used during the quality assessment of the alternative frequencies.

Evaluation of the alternative signals should be performed in a manner that is as time-efficient as possible.

There are three possible metrics that could be used for this evaluation process, in a time-efficient manner: RSSI, DP and SNR.

The SNR metric will provide the most useful information, and so it is the value that is recommended to be used if it is possible to do so.

During the burst off-time, the receiver should cycle through the list of frequencies provided, and lock to each one. The TPS cell-id bits should be checked (to verify that this signal is indeed from the expected cell), and an SNR value should be estimated for each frequency.

The frequency with the strongest SNR value should be considered the "best alternative" signal.

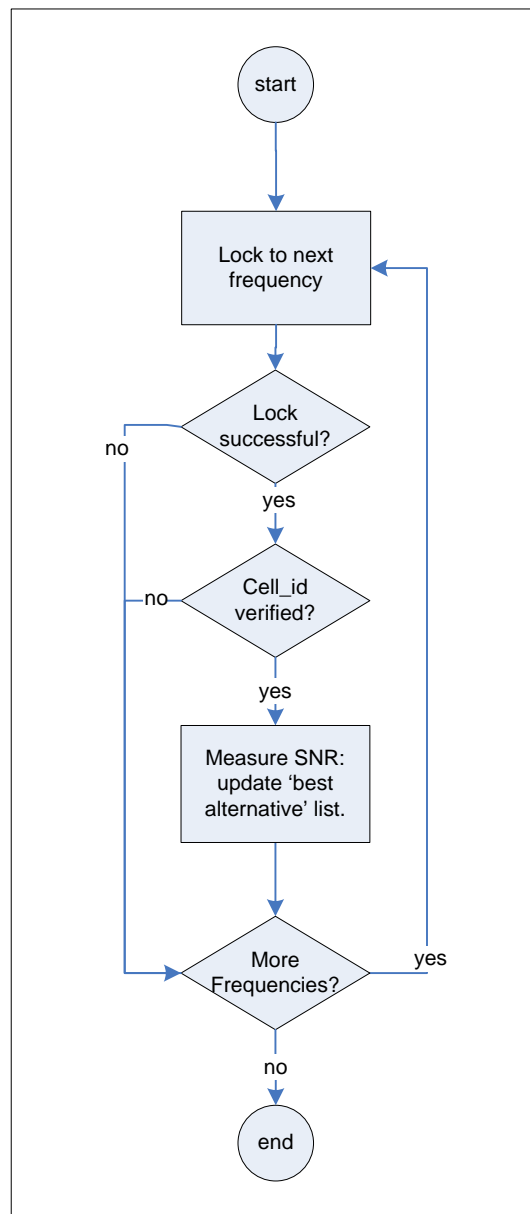

**Figure 23: Monitor alternative signal quality**

## 6.2.6 Handover execution

After handover criteria have been met, the handover actually may be performed. Two algorithms for handover have been outlined in clause 5.1.1. The first one is based on the TPS and NIT and is limited to certain handover situations. This algorithm is described in detail in clause 6.2.6.1. The second algorithm, based on TPS, INT and NIT is suitable in all handover cases. It is described in clause 6.2.6.2.

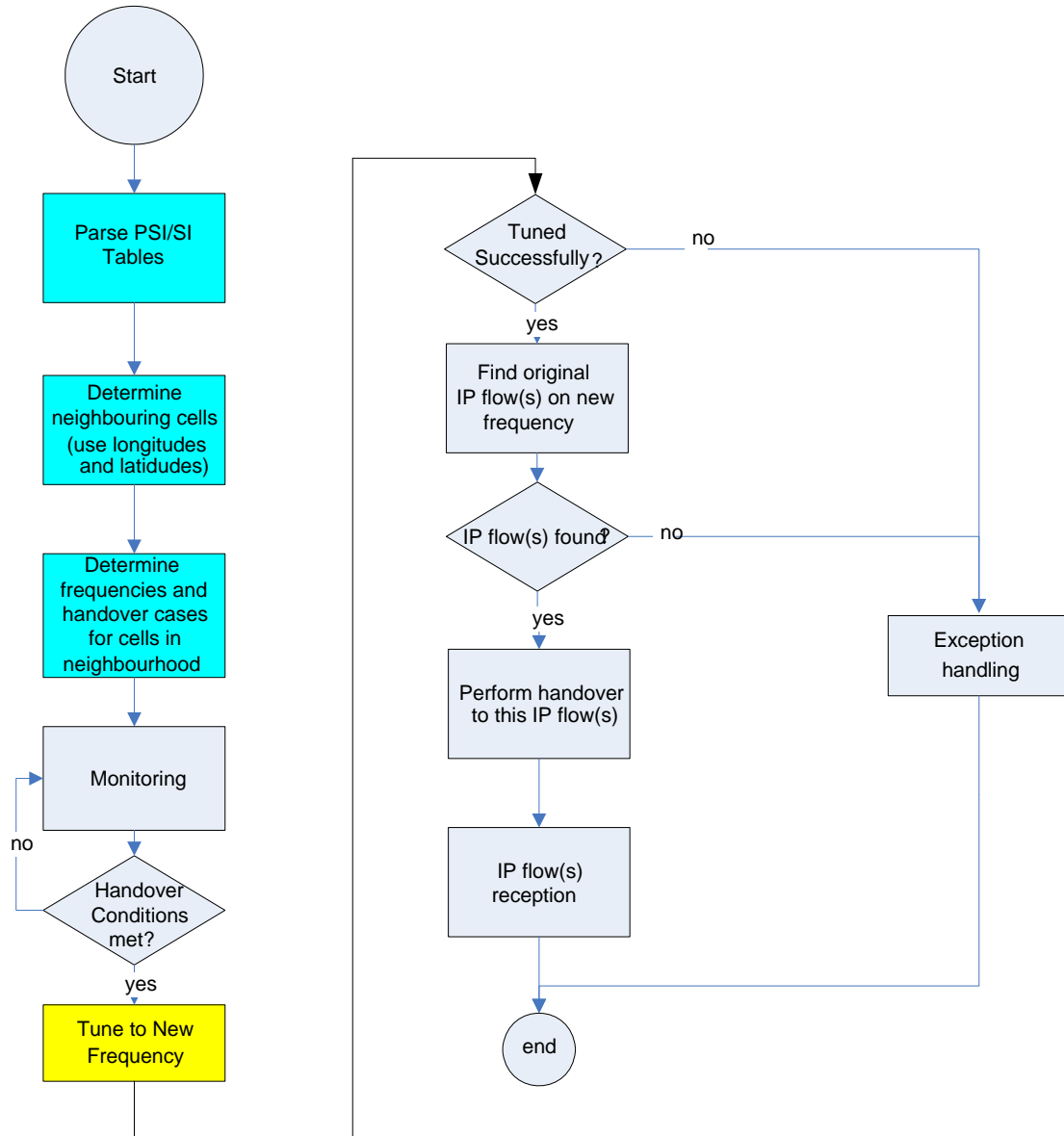

**Figure 24: Handover procedure**

In order to reduce the probability for data loss, the terminal should attempt to perform handover directly after a time slice was received from the currently consumed service from the current signal (see also TR 102 377 [7]).

### 6.2.6.1 Handover based on TPS and NIT

This method assumes that handover conditions may exist to avoid INT parsing. This is true in the case of cell/sub cell ID and Network ID changes (Network ID change restricted to the condition: target NIT available, as shown in table 1), but the transport stream remains the same [7].

#### Pre-conditions:

- 1) Signal Scan / Initialization and bootstrap have already taken place.
- 2) At least one good network signal carrying a TS has been identified, and this signal has been locked onto.
- 3) There is relevant PSI/SI signalling available.
- 4) A service is being provided. The service is described by: service\_id; transport\_stream\_id; original\_network\_id, network\_id. The IP Platform is described by: platform\_id.
- 5) At least one signal from a neighbouring cell is carrying exactly the same transport stream the receiver is currently consuming.

#### Receiver Recommendations:

- 1) The receiver must refresh its NIT\_actual and NIT\_other information every time a new multiplex is entered.
- 2) If NIT\_other is not available, the receiver may tune to other frequencies during the "off-cycle" of the burst, and derive NIT\_other information by so-doing.

NOTE: See clause 5 in TS 102 470 [4] for complete list of mandatory and optional signalling that needs to be provided by the network.

- 3) TPS bits will always be transmitted on DVB-H networks.
- 4) When TPS bits are transmitted, then the "cell\_list descriptor" and the "cell\_frequency\_link descriptor" must be available in the NIT. This frequency list must be complete.

### 6.2.6.2 Handover based on INT, TPS and NIT

The limited handover TPS and NIT method described in clause 6.2.5.1 shall be replaced by the INT, TPS and NIT method when conditions defined in clause 6.2.5.1 are not met. This method should be used when a terminal sees that the original network ID and/or the transport stream ID changes as summarized in Table 1. The method relies on the fact that INT tables announce IP Flows of the same IP Platform on other networks. This method works with the same restricted conditions as clause 6.2.5.1 in the case of cell\_id / subcell\_id and network\_id changes, i.e. INT tables shall announce IP Flows of the same IP Platform on other networks and target NIT is available.

#### Pre conditions:

- 1) Signal Scan / Initialization and bootstrap have already taken place.
- 2) At least one good network signal carrying a TS has been identified, and this signal has been locked onto.
- 3) There is relevant PSI/SI signalling available.
- 4) A service is being provided. The service is described by: service\_id; transport\_stream\_id; original\_network\_id, network\_id. The IP Platform is described by: platform\_id.
- 5) At least one signal from a neighbouring cell is carrying exactly the same IP Flow the receiver is currently consuming.
- 6) INT table announces all IP Streams on the actual TS; and it will also announce all relevant IP Streams on "neighbouring TSs".

#### Receiver Recommendations:

- 1) The receiver should refresh its INT information every time a new multiplex is entered.

**Network Recommendations:**

- 1) It is recommended that the INT is announced by adding a linkage\_descriptor with linkage\_type 0x0B into the NIT on the actual TS. The list of announced INTs must be complete.
- 2) If the NIT cannot be used for announcing INTs, then the linkage\_type 0x0C will announce the BAT on the TS. The BAT will contain linkage\_type 0x0B.
- 3) If a TS carries no INT (and therefore no IP Streams), the NIT on the particular TS should still announce INTs on other TSs of the actual network.

NOTE: See clause 5 in TS 102 470 [4] for complete list of mandatory and optional signalling that needs to be provided by the network.

- 1) Cell\_id is mandatory for each cell where DVB-H services are delivered. The cell\_id has to be announced in TPS bits as well as in the DVB SI.
- 2) The NIT actual shall announce all multiplexes of the actual delivery system, and it shall contain one or more cell\_list\_descriptors announcing cells and sub-cells of the network. This list of cells and sub-cells shall be complete.
- 3) To better support handover between networks, the presence of NIT\_other for each adjacent network is proposed (and recommended).
- 4) The receiver can achieve handover only if it knows the requested IP Flow is available on another multiplex and/or frequency:
  - It is very important that a multiplex announces the content of adjacent multiplexes by means of INT announcing IP Flows on adjacent cells, that all frequencies of each multiplex are announced in the NIT\_actual, and that the geographical locations of each cell is announced in the NIT\_actual.
- 5) If the INT does not indicate that a particular IP Flow is available on a particular TS, then the receiver may assume that it is not available on the TS.

## 6.3 Roaming and special mobility cases implementation guidelines

IPDC roaming is the procedure by which terminal finds an available ESG and a Roaming IPDC Operator that the terminal can access and consume IPDC services.

The success to access services in the roaming situation depends on the up-to-date information about IPDC Operators available for roaming. That includes the information that is pre-provisioned in the terminal as well as the signalling provided to the terminal while roaming.

A simple roaming strategy is to select the first IPDC Operator found and try to access services with "trial and error".

A more optimised method to get an access to the services in a roaming situation, i.e, to find IPDC Operator(s) whose services terminal is able to access, is to efficiently utilize all the provisioned information for roaming. The following is a generic description of such a roaming procedure. Actual implementations of the generic procedure may vary.

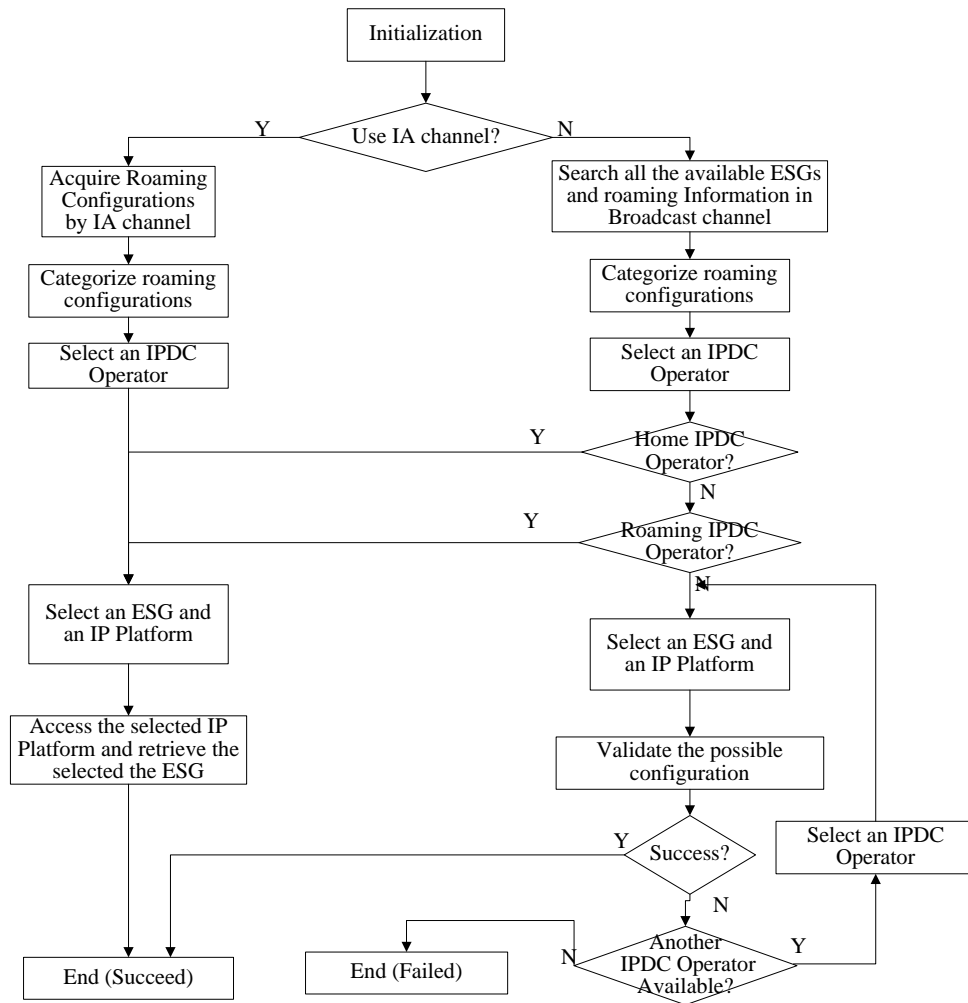

**Figure 25 Roaming Procedure**

For the broadcast network the procedure is:

- Terminal initialize the roaming procedure by collecting terminal provisioned useful parameters;
- The terminal accesses to the broadcast network, and collects the information of ESGs in all the IP Platforms, as well as local IPDC Operator and roaming IPDC Operator information that is signalled in the RoamingInformation Descriptor;
- The terminal categorizes roaming configurations;
- The terminal/user select one of the IPDC Operators available, and consequently the ESG and the IP Platform which the selected IPDC Operator is present in
  - ✦ If the selected IPDC Operator is home IPDC Operator, the terminal may access the ESG and consume IPDC services in it.
  - ✦ If the selected IPDC Operator is one of the roaming partner IPDC Operators, the terminal may access the ESG and consume IPDC services in it.
  - ✦ If the selected IPDC Operator is an unknown IPDC Operator, terminal may access the ESG and try to consume IPDC services in it. If failed, terminal may select another unknown IPDC Operator and try again.

Each of the above steps will be introduced in the following sections.

### 6.3.1 Initialization

Before IPDC roaming, the terminal may collect some information which may be useful to speed up the roaming procedure. The information includes:

- Home IPDCOperatorId-IPDCKMSId pair, which SHOULD be provisioned to terminal, is the identifier of terminal's home IPDC Operator;
- Compatible IPDCKMSId(s), which SHOULD be provisioned to terminal, is (are) the identifiers of the key management systems the terminal is able to deal with;
- Home IP platform\_id (and optionally the DVB Network\_ID), which MAY be provisioned to terminal, is the identifier of IP Platform to which terminal should access to find its home IPDC Operator. When in the range between 0xFFFF000 and 0xFFFFFFE, the IP platform\_id should be coupled with DVB Network\_ID to uniquely identify the IP Platform.
- Home ProviderURI (ESG\_URI in case of Phase II), which MAY be provisioned to terminal, is the identifier of the ESG that terminal may access to (by default).
- Roaming IPDCOperatorId-IPDCKMSId pairs, which MAY be provisioned to terminal, are the identifiers of IPDC Operators that have IPDC roaming agreement with terminal's home IPDC Operator;

### 6.3.2 Search all the available roaming configurations in Broadcast Network

In order to find a proper Roaming configuration (i.e. IP Platform, ESG, IPDC Operator) in a broadcast network, the terminal may collect information about all the ESGs and IPDC Operators in all IP Platforms available in terminal's current location. It is done by receiving and analyzing ProviderDiscoveryDescriptors and RoamingInformation Descriptor (if found) in every available ESG bootstrap. A detailed procedure is described below:

- Step 1: terminal receives all available INT sub-tables, each of which corresponds to an IP Platform;
- Step 2: terminal selects an available IP Platform, and accesses to the ESG bootstrap on the IP Platform, as defined in [3];
- Step 3: terminal receives and analyzes ESGProviderDiscovery Descriptor and RoamingInformation Descriptor (if available), to collect all the potential roaming configurations on this IP Platform.
- Step 4: in case there is an IP Platform that have not been accessed, continue with step 2; otherwise end this procedure.

At the end of the procedure, there will be a list of potential roaming configurations, each configuration in the list includes IP platform\_id (possibly coupled with DVB Network\_id), ESG\_URI (ProviderURI in legacy cases) and the IPDCOperatorId-IPDCKMSId pair.

### 6.3.3 Categorize and select Roaming Configurations

#### 6.3.3.1 Categorize Roaming Configurations

After collecting all the roaming configurations, the terminal may categorize the parameters of each configuration:

- IP Platform: it is identified as home IP Platform or visited IP Platform, by comparing the platform\_id with Home IP platform\_id. In the non-unique range, when between 0xFFFF000 and 0xFFFFFFE, the platform\_id should be coupled with the network\_id.
- ESG: it is identified as home ESG or visited ESG, by comparing the ESG\_URI (ProviderURI in legacy cases) with home ESG\_URI (ProviderURI in legacy cases).
- IPDC Operator: it is identified as Home IPDC Operator, Roaming IPDC Operator or Unknown IPDC Operator. A Roaming IPDC Operator may be identified by the fact that:

- ✦ The local IPDCOperatorId-IPDCKMSId pair obtained from the RoamingInformation Descriptor is in the roaming IPDC Operator list provisioned in the terminal, or
- ✦ The home IPDCOperatorId-IPDCKMSId pair is signaled in the list of roaming partners of a Local IPDC Operator obtained from the RoamingInformation Descriptor.

### 6.3.3.2 Select a Roaming Configuration

The terminal or user may select one of the roaming configurations according to its preference. It is done by:

Step 1: Select an IPDC Operator.

- ✦ If the Home IPDC Operator or any of the Roaming IPDC Operators are present, the terminal or user may select one of them.
- ✦ If not, the terminal may select one of the Unknown IPDC Operators available. Particularly, the terminal should select the IPDC Operator with a KMS system that the terminal can deal with.

Step 2: Select an ESG

- ✦ If several ESGs contain the selected IPDC Operator, the terminal may select one of them, for instance according to the signaling associated to the ESG entries in the ESGProviderDiscovery Descriptor.
- ✦ Alternatively, the terminal may select an ESG carrying clear-to-air-services independent of the IPDC Operator based on the information available in the RoamingInformation Descriptor.

Based on the results of steps 1 and 2, the terminal is able to retrieve the corresponding IP Platform.

### 6.3.3.3 Mapping to use cases

The relationship between the different configurations and the mobility use cases described in section 5.2 is as following:

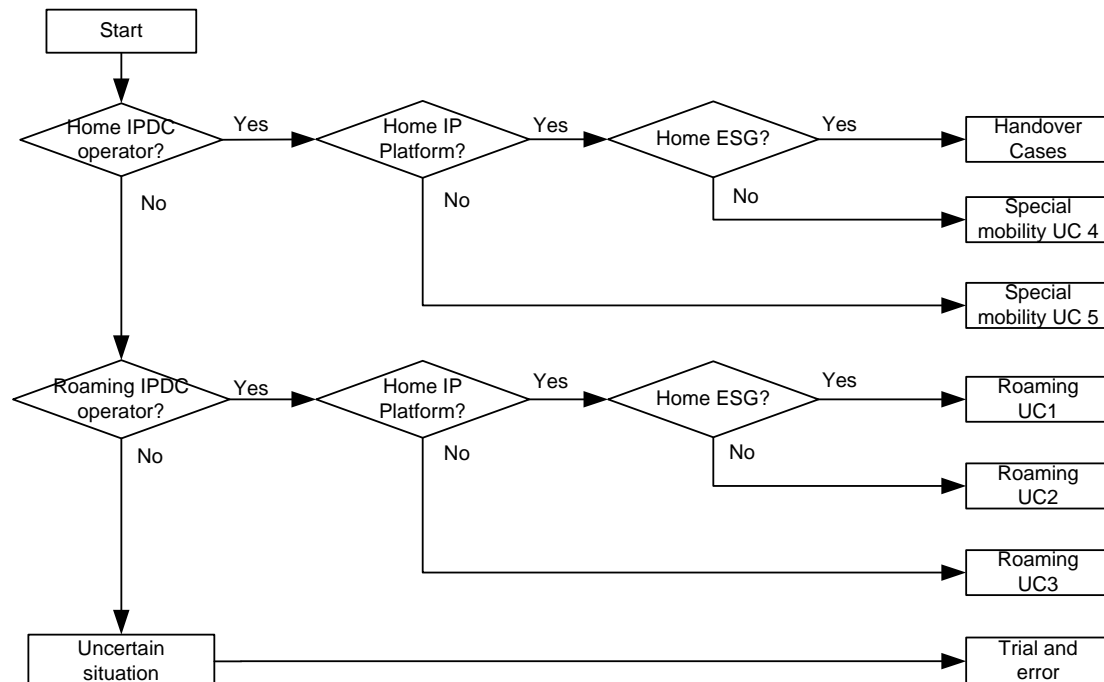

**Figure 26: Relation between potential roaming configurations and mobility use cases.**

### 6.3.4 Acquire roaming configurations via interactive network

There are two possible mechanisms for acquiring roaming configurations via the interactive network. One is a generic IPDC mechanism described in [3]. The second option is to use a mechanism based on OMA DM where the terminal

makes the roaming configuration selection according to an IPDC MO, which is acquired from the home DM server before roaming or is requested when roaming. The IPDC MO is described in [3].

### 6.3.5 Access an ESG

After selecting one ESG, the terminal can access it as described in [3].

### 6.3.6 Validate an roaming configuration

If the terminal selects one of the Unknown IPDC Operators, the terminal will need to validate the roaming configuration. After selecting an IPDC Operator and after accessing an ESG, the terminal may check whether this is a working roaming configuration. This check can be done by e.g. performing a purchase.

Note: This process is time-consuming, therefore may gear down the roaming speed.

## Annex A (normative): ESG bootstrap extension for mobility support

### A.1 Introduction

The RoamingInformation Descriptor that will be defined in the following provides quickly accessible information in the ESG bootstrap so that a terminal is able to quickly obtain information of which Local IPDC Operators are present on a certain ESG, which roaming partners the Local IPDC Operators have and whether clear-to-air services are present in that ESG.

The RoamingInformation Descriptor is optional for the network infrastructure and the terminal. However, if used, it shall follow the specifications in this Annex.

If the RoamingInformation Descriptor is used, the Local IPDC Operators and the availability of clear-to-air services shall be signaled. However, signaling of roaming partners (i.e. the second loop of the descriptor) is optional.

### A.2 RoamingInformation Descriptor

#### A.2.1 Syntax

**Table 4: Syntax of the RoamingInformation Descriptor**

Syntax	No. of bits	Mnemonic
RoamingInformation Descriptor{		
Version_no	8	Uimsbf
Descriptor_tag	8	Uimsbf
n_o_Operators	8	uimsbf
for(i=0; i<n_o_Operators; i++){		
Operator_Index[i]	8	uimsbf
IPDC_Operator_ID[i]	16	uimsbf
KMS_ID[i]	16	uimsbf
}		
n_o_local_Operators_with_signaled_Roaming_Partners	8	uimsbf
for(i=0; i<n_o_local_Operators_with_signaled_Roaming_Partners; i++){		
Local_Operator_with_signaled_Roaming_Partners_Index[i]	8	uimsbf
N_o_Roaming_Partners_signaled[i]	8	uimsbf
for(k=0; k<n_o_Roaming_Partners_signaled[i]; k++){		
Signaled_Roaming_Partner_Index[i][k]	8	uimsbf
}		
}		
n_o_ESG_IDs	8	uimsbf

for(i=0; i< n_o_ESG_IDs; i++){		
ESG_ID[i]	16	uimsbf
Clear-to-air_services_available[i]	8	uimsbf
N_o_local_Operators_on_ESG[i]	8	uimsbf
for(k=0; k< n_o_local_Operators_on_ESG[i]; k++){		
local_Operator_on_ESG_Index[i][k]	8	uimsbf
}		
}		

## A.2.2 Semantics

**Table 5 [5]: Semantics of the RoamingInformation Descriptor**

Field	Semantics
Version_no	Specifies the version of roaming information descriptor. The value shall be 1.
Descriptor_tag	Identifies uniquely the descriptor.
n_o_Operators	Specifies the number of the IPDC Operators used in the following loop.
Operator_Index	Specifies the index for the i <sub>th</sub> IPDC Operator used for referencing in the lower part of the descriptor.
IPDC_Operator_ID	Specifies the IPDCOperatorId for the i <sub>th</sub> IPDC Operator.
KMS_ID	Specifies the IPDCKMSId for i <sub>th</sub> IPDC Operator.
n_o_local_Operators_with_signaled_Roaming_Partners	Specifies the number of the local IPDC Operators for which roaming partners are signaled. In the case that roaming partners are signaled for none of the local IPDC Operators, the parameter should be set to 0.
local_Operator_with_signaled_Roaming_Partners_Index	Specifies the index of the i <sub>th</sub> local IPDC Operator with signalled roaming partners
n_o_Roaming_Partners_signaled	Specifies the number of roaming partners signaled for the i <sub>th</sub> local IPDC Operator with roaming partners.
Signaled_Roaming_Partner_Index	Specifies the index of the k <sub>th</sub> roaming partner of the i <sub>th</sub> local IPDC Operator with roaming partners.
n_o_ESG_IDs	Specifies the number of ESGs.
ESG_ID	Specifies ESGID for the i <sub>th</sub> ESG
clear-to-air_services_available	(MSB first):  b0xxxxxxx: no CTA  b10000000: CTA available  b1yyyyzzz: yyyy CTA services which are permanently available (if yyyy=1111 it would

	mean 15 or more); zzz services available CTA only part-time (if zzz=111 it would mean 7 or more)
n_o_local_Operators_on_ESG	Specifies the number of local IPDC Operators in the i_th ESG
local_Operator_on_ESG_Index	Specifies the index of the k_th local IPDC Operator on the i_th ESG.

### A.2.3 Transport

The RoamingInformation Descriptor is transported in the ESG Bootstrap FLUTE session in a well-known IP address and port, as defined in [3].

Additionally the following restrictions apply:

The RoamingInformation Descriptor is transported in a dedicated transport object in the bootstrap FLUTE session. It should be signaled in the FDT by setting the attribute

Content-Type="application/vnd.dvb.ipdcroaming"

---

## Annex B (informative): Bibliography

- ETSI TS 102 468: "Digital Video Broadcasting (DVB); IP Datacast over DVB-H: Set of Specifications for Phase 1".

## History

<b>Document history</b>		
V0.0.1	23 <sup>rd</sup> June 2008	<ol style="list-style-type: none"> <li>1. skeleton drafted</li> <li>2. text copied from TS 102 611 v1.1.1 and #1723 v0.0.9.</li> <li>3. renumber the chapters and sections</li> <li>4. delete overlapping references.</li> <li>5. correct numbers of reference, tables and figures.</li> </ol>
V0.0.2	10 <sup>th</sup> July 2008	<ol style="list-style-type: none"> <li>1. change of the document title</li> <li>2. change in introduction section</li> <li>3. copy text into scope section</li> <li>4. reordered section 4</li> <li>5. reordered section 5 with also renumber the sections figures.</li> <li>6. revise the cross references</li> <li>7. removed copy-paste notes.</li> </ol>
V0.0.3 (r2)	August 27 <sup>th</sup> , 2008	Editing at CBMS #59
V0.0.4 (r3)	September 5 <sup>th</sup> , 2008	Included inputs #2221, #2222
V0.0.5 (r4)	September 16 <sup>th</sup> , 2008	Editing at mobility teleconference